

Balboa's BP Troubleshooting & Service Manual

THIS MANUAL COVERS THE FOLLOWING:

SPA CONTROL SYSTEMS

BP600
BP2100G1

PANELS

TP900, TP800,
TP600, TP400

50 Hz



BALBOA
water group

Introduction

Intellectual Property Advisement

All Intellectual property, as defined below, owned by or which is otherwise the property of Balboa Water Group or its respective suppliers relating to the Balboa Water Group BP Spa Control Systems, including but not limited to, accessories, parts, or software relating to the "System", is proprietary to Balboa Water Group and protected under federal laws, state laws, and international treaty provisions. Intellectual Property includes, but is not limited to, inventions (patentable or unpatentable), patents, trade secrets, copyrights, software, computer programs, and related documentation, and other works of authorship. You may not infringe or otherwise violate the rights secured by the Intellectual Property. Moreover, you agree that you will not (and will not attempt to) modify, prepare derivative works of, reverse engineer, decompile, disassemble, or otherwise attempt to create source code from the software. No title to or ownership in the Intellectual Property is transferred to you. All applicable rights of the Intellectual Property shall remain with Balboa Water Group and its suppliers.

End User Warning

This Installation Manual is provided solely to aid qualified spa service technicians in installing spas with control systems manufactured by Balboa Water Group. Balboa controls have absolutely no end user serviceable parts. Balboa Water Group does not authorize attempts by the spa owner/user to repair or service any Balboa products. Non-qualified users should never open or remove covers, as this will expose dangerous voltage points and other dangerous risks. Please contact your dealer or authorized repair center for service.

RCD

It is strongly advised to install an RCD (Residual Current Device) in the supply power to a spa. Also, an RCD should be tested periodically. This device will trip the breaker if there is an unsafe electrical condition caused by a malfunctioning component or even the slightest short to ground.

Note: Follow all local electrical codes upon installation, diagnosis, or testing of the RCD.

Warnings: Danger! Risk of Electric Shock!

- All electrical work must be performed by a qualified electrician and must conform to all national, state, and local codes.
- Before making any electrical connections, make certain that the Main Power breaker from the house breaker box has been turned off.
- Do not attempt service of this control system unless you are qualified. Contact your dealer or service organization for assistance.
- Do not permit any electric appliance, such as a light, telephone, radio, or television within 5' (1.5m) of a pool or spa.
- Follow all owner's manual power connection instructions.
- Installation must be performed by a licensed electrician and all grounding connections must be properly installed.
- No user serviceable parts.
- Water temperature in excess of 38°C may be injurious to your health.
- Disconnect the electrical power before servicing.
- Keep access door closed.

CAUTION

- Test the ground fault circuit interrupter before each use of the spa.
- Read the instruction manual.
- Adequate drainage must be provided if the equipment is to be installed in a pit.
- To ensure continued protection against shock hazard, use only identical replacement parts when servicing.
- Install a VG Compliant suction guard that is suitably rated to match the maximum flow rate marked.

WARNING:

- Water temperature in excess of 38°C may be injurious to your health.
- Disconnect the electrical power before servicing.
- Keep access door closed.

Codes and Compliance

All of the electrical wiring methods and materials used to complete the electrical installation of the BP control systems must be in accordance with the National Electrical Code or the Canadian Electric Code, as well as any local electrical codes in effect at the time of installation.

The selection of electrical materials required to accomplish this installation and the installation of the control system must be made by, or be under the direct supervision of, a qualified electrician.

The systems herein are classified as a “continuous duty appliance” and is intended primarily for installation at a single family dwelling. The installation recommendations and instructions contained in this manual are directed solely toward these issues.

WARNING!

If there is any doubt whether the system that you are repairing does not have these features, contact a licensed, qualified electrician. **Do not attempt to modify the wiring yourself.**

BP Diagnostic Service Manual

This manual is for general servicing of BP Control systems, and troubleshooting typical spa control system problems. For detailed component settings and wiring configurations, service technicians should obtain the latest technical manuals (Tech Sheets) available.

Contact your Balboa Water Group representative or BWG's technical support for technical materials. Or, visit Balboa Water Group at: <http://www.balboawatergroup.com/>

Warning! Qualified Technician Required for Service and Installation

Basic Installation and Configuration Guidelines

Use minimum 6AWG copper conductors only.

Torque field connections between 21 and 23 in lbs.

Readily accessible disconnecting means to be provided at time of installation.

Permanently connected.

Connect only to a circuit protected by a Class A Ground Fault Circuit Interrupter (GFCI) or Residual Current Device (RCD) mounted at least 5' (1.52M) from the inside walls of the spa/hot tub and in line of sight from the equipment compartment.

CSA enclosure: Type 2

Refer to Wiring Diagram inside the cover of the control enclosure.

Refer to Installation and Safety Instructions provided by the spa manufacturer.

Warning: People with infectious diseases should not use a spa or hot tub.

Warning: To avoid injury, exercise care when entering or exiting the spa or hot tub.

Warning: Do not use a spa or hot tub immediately following strenuous exercise

Warning: Prolonged immersion in a spa or hot tub may be injurious to your health

Warning: Maintain water chemistry in accordance with the Manufacturer's instructions.

Warning: The equipment and controls shall be located not less than 1.5 meters horizontally from the spa or hot tub.

Warning! GFCI or RCD Protection.

The Owner should test and reset the GFCI or RCD on a regular basis to verify its function.

Warning! Shock Hazard! No User Serviceable Parts.

Do not attempt service of this control system. Contact your dealer or service organization for assistance. Follow all owner's manual power connection instructions. Installation must be performed by a licensed electrician and all ground- ing connections must be properly installed.

CSA Compliance/Conformité

Caution:

- Test the ground fault circuit interrupter or residual current device before each use of the spa.
- Read the instruction manual.
- Adequate drainage must be provided if the equipment is to be installed in a pit.
- For use only within an enclosure rated CSA Enclosure 3.
- Connect only to a circuit protected by a Class A ground fault circuit interrupter or residual current device.
- To ensure continued protection against shock hazard, use only identical replacement parts when servicing.
- Install a suitably rated suction guard to match the maximum flow rate marked.

Warning:

- Water temperature in excess of 38°C may be injurious to your health.
- Disconnect the electrical power before servicing.

Attention:

- Toujours vérifier l'efficacité du disjoncteur différentiel avant d'utiliser différentiel avant d'utiliser le bain.
- Lire la notice technique.
- Lorsque l'appareillage est installé dans une fosse, on doit assurer un drainage adéquat.
- Employer uniquement à l'intérieur d'une clôture CSA Enclosure 3.
- Connecter uniquement à un circuit protégé par un disjoncteur différentiel de Class A.
- Afin d'assurer une protection permanente contre le danger de shock électrique, lors de l'entretien employer seulement des pièces de rechange identiques.
- Les prises d'aspiration doivent être équipées de grilles convenant au débit maximal indiqué.

Avertissement:

- Des températures de l'eau supérieures à 38°C peuvent présenter un danger pour la santé.
- Déconnecter du circuit d'alimentation électrique avant l'entretien.

Warning/Advertissement:

- Disconnect the electric power before servicing. Keep access door closed.
- Déconnecter du circuit d'alimentation électrique avant l'entretien. Garder la porte fermée.

Table of Contents

Introduction	2
Intellectual Property Advisement	.2
End User Warning	.2
RCD	.2
Warnings: Danger! Risk of Electric Shock!	.2
Codes and Compliance	.3
BP Diagnostic Service Manual	.3
Equipment Overview	7
Service Tools and Parts Checklist	.7
TP Panel Overview and User Guides	.8
Product Identification	.9
230 Volt / 50 Hz Residential Wiring Schematic with 2 Pole RCD Breaker Box	10
General Troubleshooting & Servicing of Spa's Electrical Equipment	12
Basic Control System Troubleshooting	13
Testing a System with Power	15
230 Volt 50 Hz - Residual Current Devices (RCD's)	17
Wiring Checks	18
Wiring Check for RCD and Service Disconnect	19
Troubleshooting Pumps, Problem & Cause	20
Acceptable Ranges for Testing Equipment	21
Fuses: Devices, Locations, and Values	22
Troubleshooting Using Resistance	23
Ohm's Law	23
Testing a Fuse: Continuity	24
Troubleshooting Heater Resistance	25
Troubleshooting Heater Posts Resistance to Heater Housing	26
Troubleshooting with Voltage	27
Verifying Incoming Voltage at the Terminal Block - BP2100 & BP600	28
Testing Pump Fuses for Damage with Voltage On - BP2100	29
Testing Heater Voltage - All BP Systems	30
A Safer Way to Test Heater Voltages	31
Testing Pump Fuses for Damage with Voltage On - BP600	32
Testing Heater Amperage	33
Testing Low Speed and High Speed at the AMP Pump Connector	34
Testing the Sensor Set	35

Table of Contents (cont.)

Component Failure and Replacement Testing	37
Software Setups and Test Mode	37
Setup Changes with DIP Switch 1 ON - Using a TP600 or TP400 Panel	38
Setup Changes with DIP Switch 1 ON - Using a TP900 or TP800 Panel	40
Removing the Heater Assembly from a BP Spa System.	41
Remove and Replace a System Circuit Board	44
TP800, TP900 Panel Operations	45
The Main Screen - Navigation	45
TP800, TP900 Priming Mode Start-up Sequence	46
TP800, TP900 Spa Behavior	47
TP800, TP900 Adjusting Filtration	48
TP800, TP900 Panel Lock & Unlock.	49
TP800, TP900 Sensor and System Related Messages.	50
TP800, TP900 Utilities Menu.	54
TP400, TP600 Standard Panel Operations	55
Main Screen - Navigation	55
TP400, TP600 Panel Utilities Menu	56
TP400, TP600 Preparation and Priming	57
TP400, TP600 Message Codes.	58
TP400, TP600 Utilities Fault Log Menu	61
TP400, TP600 Utilities Menu - GFCI Test Feature	62
TP400, TP600 Simplified vs. Standard Panel Operations.	63
TP400, TP600 Simplified and Standard Panel Main Menus	64
Balboa Water Group BP Wiring Diagrams.	65
Wiring Diagram - BP2100G1, Part Number 56389-01	65
Wiring Diagram - BP21MSSH, Part Number: 56381	67
Wiring Diagram - BP600/BP1600, Setup 1-16 as Manufactured	69
Wiring Diagram - BP600/BP1600, Setup 2-32 as Manufactured	70
Supplemental Information.	71
Optional Balboa Dolphin™ Remote.	71
Spa Guidelines to Keep in Mind	73
Glossary	74
Index	75
Index of Paragraph Topics	80

Equipment Overview - Service Tools and Parts Checklist

SERVICE TOOLS REQUIRED

- Ammeter (50A) with Insulated Clamps for Probes
- Screwdrivers, Assorted Flat and Phillips
- Digital Multi-meter
- Padlock (to lock electrical disconnect during service)
- Pliers: Slip Joint & Needle Nose
- Precision Thermometer - Digital Fever Type
- Silicone Tube
- Small Wire Cutters
- 3/8" and 1/4" Open End Wrenches (heater wire nut removal)



FUSES USED ON BP SPA SYSTEMS

Fuse	BWG Part Number
30A	30136
10A	30122
3A Slo-Blo	20600
0.3A Slo-Blo	21581
0.15A Slo-Blo	26281
0.125A Slo-Blo	26397

RECOMMENDED PARTS TO HAVE FOR SERVICE CALLS

- Extra Board(s)
- Extra Panel(s)
- Fuses
- Jumpers
- Heater Assemblies
- Sensor Wires (No. 30344, sensor wire for example).



BP2100 Circuit Board



Heater Assembly

TP Panel Overview and User Guides

TP900



TP800



TP600



TP400



System Models: BP2000 and other BP-Series Systems as required.

Panel Model: TP900 Series, TP800 Series

Software Version(s): Software versions vary and are constantly changing. See Tech Sheets for latest version and software compatibility.

User Guide **40985**

System Models: BP500 and other BP-Series Systems as required.

Panel Model: TP600 Series, TP400 Series

Software Version(s): Software versions vary and are constantly changing. See Tech Sheets for latest version and software compatibility.

- User Guide 40940
User Interface and Programming Reference – Standard Menus
- User Guide 42185; Ref. Card 40947
User Interface and Programming Reference – Simplified Menus
(See section **TP400, TP600 Simplified vs. Standard Panel Operations** for more information.)

NOTE: All TP panels work with all BP Spa Control Systems. They all have capabilities for navigation, setting functions and modes, such as time, temperature, filter cycles, preferences, sensor related messages, reminder messages, diagnostic messages, and utilities such as fault logs.

Product Identification



On Every System, an Identification Label Is Placed on Top of the Casing



Heater Element Specifications Are Shown on the Heater Tube Label

On Every System, a Wiring Diagram Is Placed Inside the Door

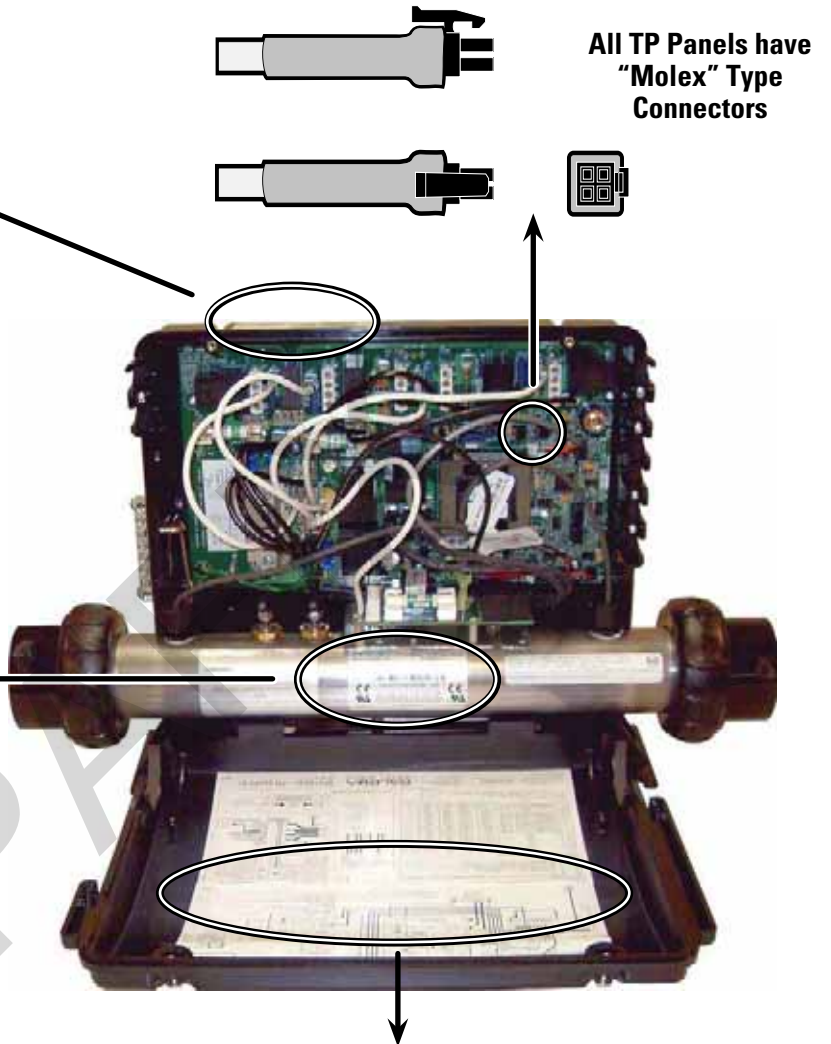

All TP Panels have "Molex" Type Connectors

BALBOA
water group

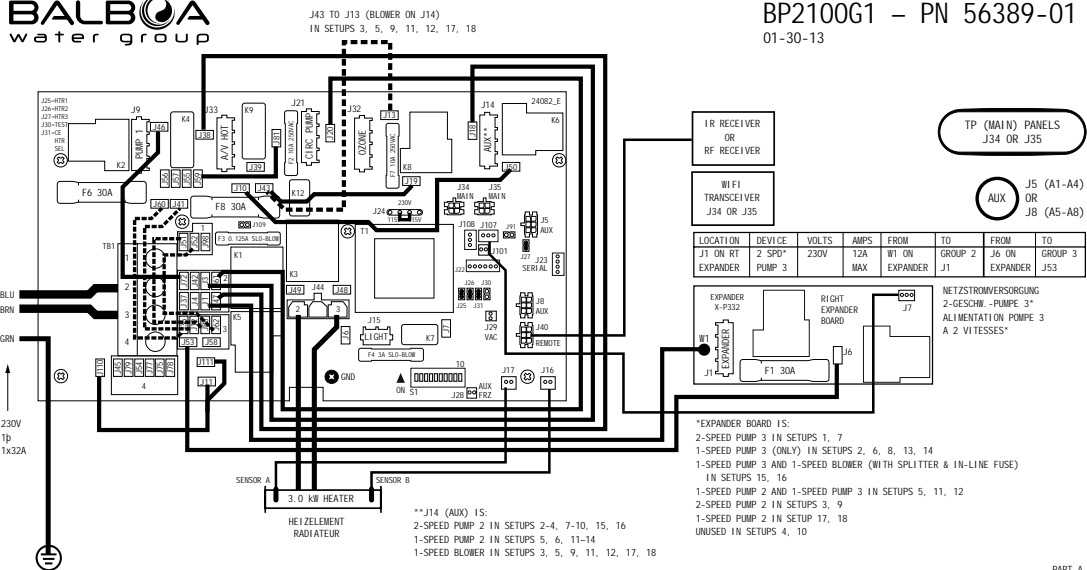

230 Volt / 50 Hz Residential Wiring Schematic with 2 Pole RCD Breaker Box

230VAC House Breaker Box

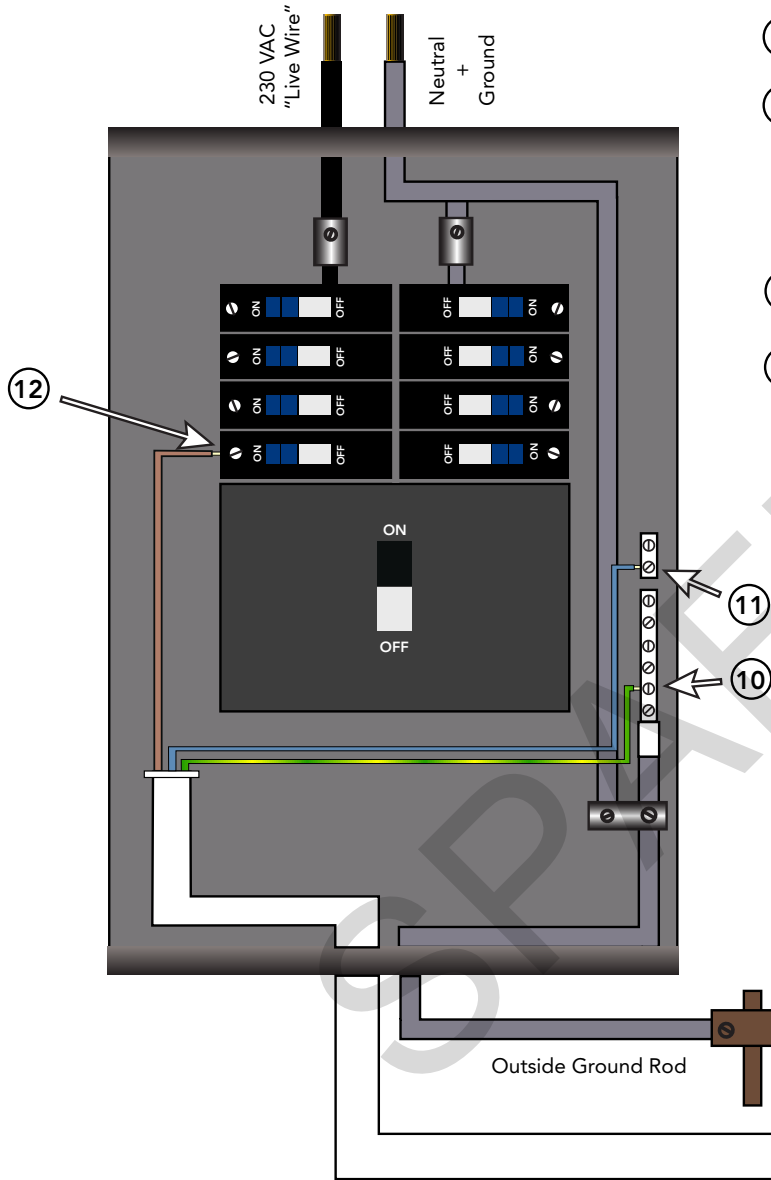

RCD Breaker Box

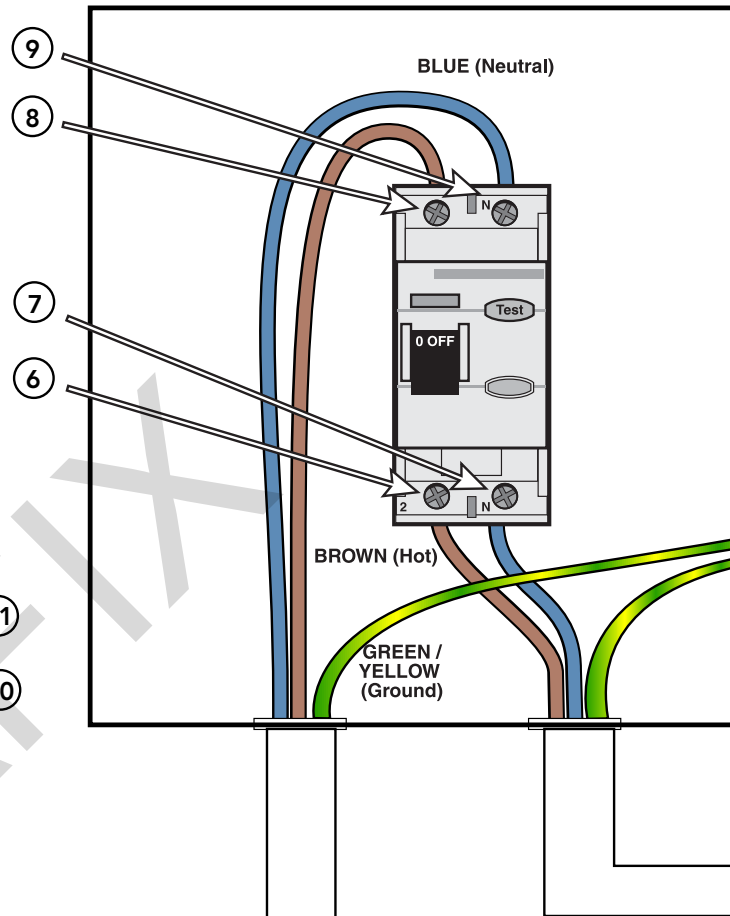

Correct Voltage	When Probes Are Placed Across
0v	[1 - 3] [4 - 7] [5 - 9] [10 - 11]
207V - 253V	[1 - 2] [2 - 3] [4 - 6] [5 - 8] [6 - 7] [8 - 9] [10 - 12] [11 - 12]

Spa System Box

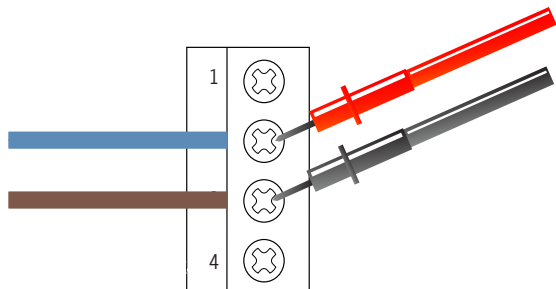
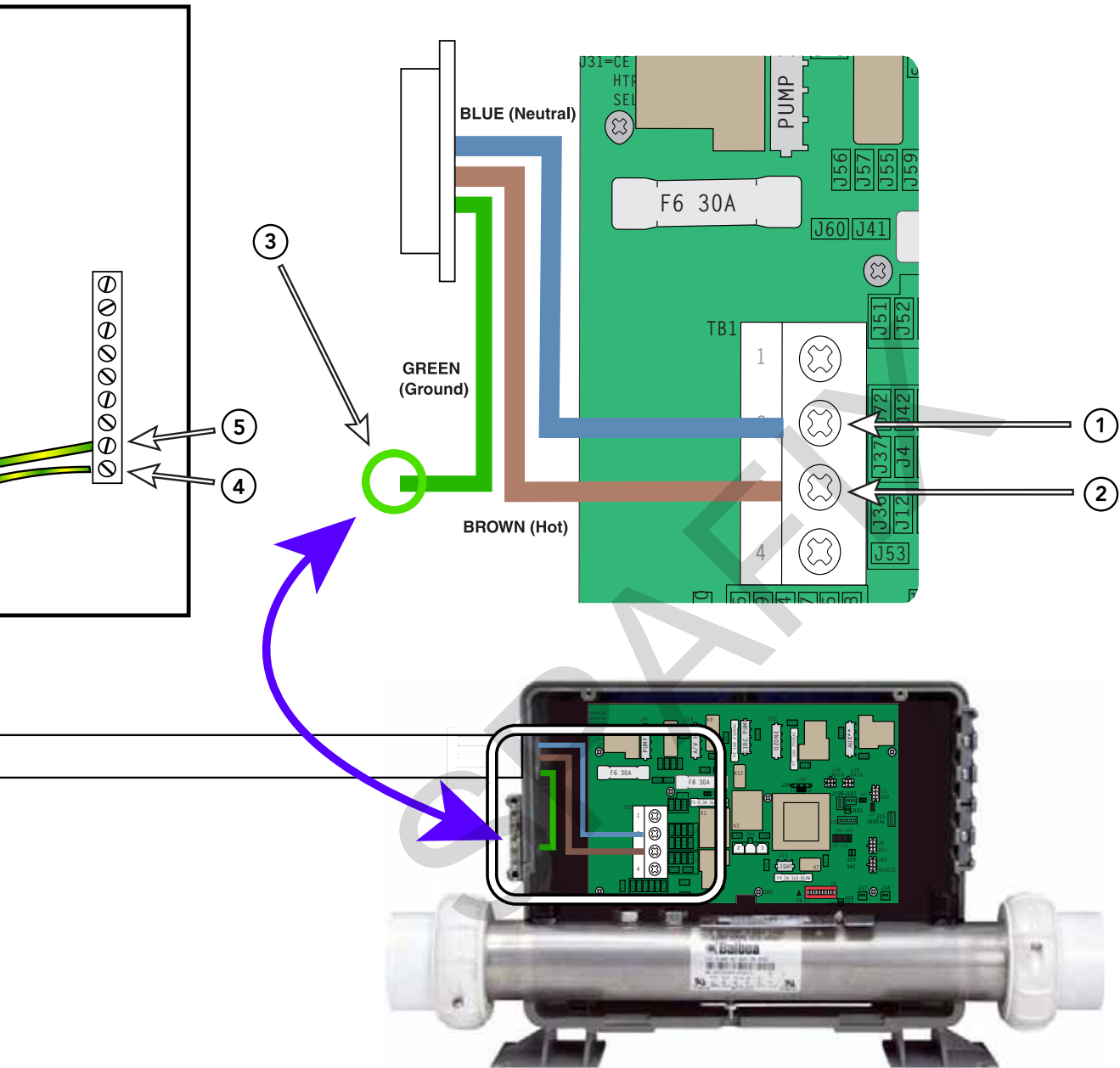

Test for Voltages by placing probes on these locations

General Troubleshooting & Servicing of Spa's Electrical Equipment

HIGH VOLTAGE CAN SERIOUSLY INJURE OR KILL!

ONLY EXPERIENCED TECHNICIANS SHOULD SERVICE THIS EQUIPMENT.

DO NOT REMOVE THE PROTECTIVE COVERS FROM ANY ELECTRICAL ENCLOSURE, OR ATTEMPT TO SERVICE ANY RELATED ELECTRICAL DEVICE, UNLESS YOU ARE A QUALIFIED ELECTRICIAN OR SERVICE PROFESSIONAL.

DANGER

Risk of electric shock. Before working with any electrical connections, make certain that the Main Power breaker from the house breaker box has been turned off.

WARNING

ALL ELECTRICAL WORK MUST BE PERFORMED BY A QUALIFIED ELECTRICIAN AND MUST CONFORM TO ALL LOCAL CODES.

IMPORTANT

DUE TO THE DANGER OF SEVERE ELECTRICAL SHOCK, LOCATE ALL POWER DISCONNECTS BEFORE SERVICING A SPA. PRECAUTIONS MUST BE TAKEN WHENEVER WORKING WITH BREAKER BOXES, G.F.C.I.'S, OR SERVICE DISCONNECTS.

Always refer to the wiring diagram that is included with each system on the inside of the system box cover. Use this diagram for voltage measurement points, and for proper reconnection of wires.



A terminal marked "GROUND" is provided within the System Control Center enclosure. To reduce the risk of electrical shock, connect this terminal to the grounding terminal of the electric supply panel with a continuous green insulated copper wire equivalent in size to the circuit conductors supplying this equipment, but no smaller than #12 AWG.



Ground in System Enclosure



SAFETY TIPS

- Keep children and pets away.
- Be aware of your surroundings. Standing in water while repairing a spa puts you at serious risk.
- Avoid working in cramped or crowded conditions.
- Consider placing a padlock on the service panel to lock out anyone who might power up the system.

Basic Control System Troubleshooting

Note: Local codes and laws vary. Use information below as a guide.

LOW VOLTAGE

At Balboa, it's been our experience that the majority of the problems associated with electronic control systems are due to low voltage.

BROWN OUTS

"Brown outs" can have an effect on the spa's operation in a variety of ways. The control panel may go blank, have scrambled messages on the LCD, or only a few features will function.

If the system is getting the proper voltage at TB1, but still doesn't operate, then test for a blown power input fuse.

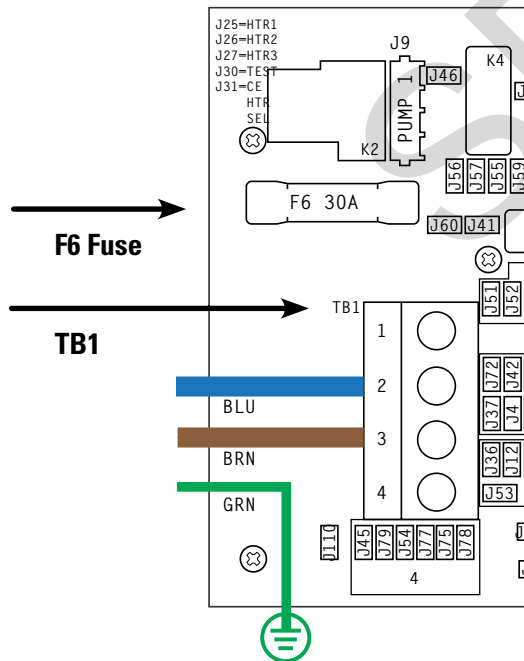

Terminal Block & F6 Fuse on a BP2100 Board

CHECKING THE SYSTEM POWER INPUT FUSE



These procedures are performed while the system is powered up and running under peak loads. Be careful.

Systems that use 230V peripheral devices (below):

- Measure between the brown TB1 terminal and F6 power input fuse at F6. You should see 230 volts.
- If you determine that there is no voltage at this location, then the system power input fuse needs to be replaced. Only use a fuse of the same type and amp rating when you replace any of these fuse.
- **NOTE FOR ALL SYSTEMS** In each situation, the most likely reason for the system power input fuse to blow is a pump problem. (cont. next page)

Once the power input fuse has been changed

- Check the voltage between the black and red wires again. Acceptable voltage range is between 216V and 264V.

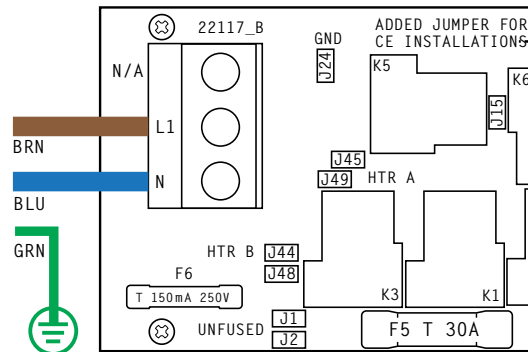

Terminal Block & F5 Fuse on a BP600 Power Board, 230V Setup

Basic Control System Troubleshooting (cont.)

THESE READINGS SHOULD BE TAKEN UNDER PEAK LOAD CONDITIONS.



IMPORTANT

If the voltage is not in the acceptable range, call an electrician or the local electric company to diagnose the problem.

TO DETERMINE THE CAUSE OF A BLOWN POWER INPUT FUSE

Perform the following *sequence of tests*.

Test the System

- Turn the power off.
- Be sure to replace the system power input fuse with the same type.
- Unplug the blower and all pumps.
- Restore the power and verify system operation.
- If the fuse blows, then re-check the internal system wires and connector for burns, cracks or cuts in insulation.
- If the fuse does not blow, turn the power off and plug in the pump.

NOTE: Be sure to test each device individually.

Test the Pump

- Restore the power and activate the pump.
- If the fuse blows, there is a pump problem.
- If the fuse does not blow, turn off the power.

Test the Blower

- Plug in the blower.
- Power up the system and activate the blower.
- If the fuse blows, then there is a blower problem.
- If the fuse does not blow, the combined pump and blower amperage may be excessive. To verify this, first check with your spa manufacturer for amperage draw limits on each device.
- Since the blower should now be running, you can check the amperage draw with an ammeter by measuring around the black blower wire and compare with manufacturer's specifications.

TEST THE AMPERAGE DRAW

Turn off the power, disconnect the blower, make sure the pump is plugged in, and restore power.

- Start the pump and switch to high speed (if available), this should draw the most current.
- Make sure all jets and valves are open.
- Check the amperage at the red pump wire. Compare your reading with manufacturer specifications. (If the other plug-in devices exist, they should be tested in the same way.)
- If the amperage draw for each device is within manufacturer's specifications, the problem could be a nuisance spike in the pump, or water in the blower.

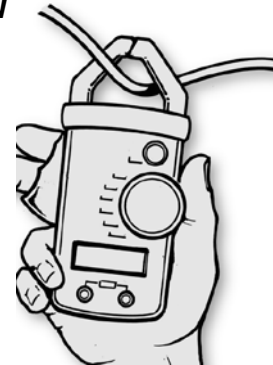

NOTE: These slow-blow fuses are not always discolored when blown. Always test continuity of a fuse with an ohmmeter.

NOTE: Miswiring of the spa is the most common reason for this fuse to blow. However, a lightning strike in the area is a possible, though less likely, cause of the failure.

Testing a System with Power

See manufacturer's owners manual or reference card for general information on operating the spa, including programming filters and other settings that are changed from the topside control panel.

HEATER START UP INFORMATION

On M-7 systems, the heater goes through a testing phase every time it starts up to assure that there is adequate water flow. This provides sophisticated dry fire and low flow protection. It can be confusing if you don't know what to expect. Step by step, here is what happens. (Note that the timing/temperature details may be slightly different on some older M7 systems.)

- Prior to heating, the pump is run for at least two minutes, and then the temperature difference between the sensors is assessed. It must be 2°F/1.0°C or less for heating to proceed, otherwise an error is issued.
- The heater turns on for 6.5 to 18 seconds (depending on heater voltage and wattage). At this point, the heat indicator on the panel is "solid". During this time the panel is not immediately responsive.
- The heater turns off for 90 seconds, making sure that the water flow keeps the temperature rise small and short. (Abnormal water flows, or lack of water, will produce a large and/or long temperature rise, and the system faults in that situation.) At this point, the heat indicator on the panel may appear to "shimmer" or "dim" (on some panels this may be less obvious from certain angles and more obvious from other angles, or in different lighting).
- If the dry fire test has passed, heating turns back on to heat the spa. The heat indicator on the panel returns to "solid".
- During spa heating, a difference between the sensors of 2°F/1.0°C, or perhaps 3°F/1.5°C (at least with 4-6kW 240V heaters), is considered normal. A significantly higher difference, however, is usually indicative of a flow problem, and will cause a fault which disables the heating for at least a minute (and then restarts the whole above process).

PRELIMINARY PANEL CHECK

- If the problem is not obvious, look on the topside control panel for diagnostic messages.
- If no messages are seen, run through all spa functions and note any inconsistent operation.
- Most error messages are stored in the fault log. To view the fault log, the spa must be in test mode and the spa light must be turned on.

Once you have determined that proper voltage is running through the circuit board and transformer, continue to the topside control panel. A panel that is not functioning properly may include the following symptoms: low voltage such as missing or scrambled

segments, missing icons on the LCD, non-functional LED's, or nonfunctional buttons. If any of these symptoms are present, perform the following:

- Turn the power off and unplug the panel from the circuit board.
- Then, plug in your test panel and restore power. If everything functions normally, replace the topside panel.
- Disconnect ozone generator (if applicable).
- If you still see symptoms of low voltage, such as a sluggish, blank or partially blank panel, or if the display or the LED's do not function at all, turn the power off; unplug the ozone generator (if equipped); then restore power to the system. If the problem persists, turn off the power and replace the circuit board.

FLASHING HEAT LED ON TP600 ("HEAT WAITING")

When there is a call for heat, the system will start the heater for a few seconds and the Heat LED will light. After a few seconds of heat, the heater will shut off for 90 seconds and the system will look at the sensors to be sure they are within the M7 parameters for flow and a safe environment to run the heater. During this 90 second wait time, the Heat LED will flash quickly, or "shimmer", until the heater comes on again to heat. There is no voltage to the heater during this cycle. This is normal for M7. Once the heater comes back on, the LED will be on without shimmering. On the TP800 and TP900 panels, the screen will display "Heat Waiting".

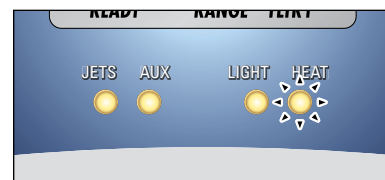

Heat LED in Heat Waiting Mode, TP600

Testing a System with Power (cont.)

MOST PROBABLE OVERHEATING CAUSES, INSPECT THESE FIRST

- Check slice or ball valves. Make sure that they are open.
- Make sure the correct pump is installed.
- Clean the filter/skimmer if there is any blockage.
- Check heater element alignment.
- Check for debris on the heater element.
- In extremely hot weather, check for proper cabinet ventilation.
- Make sure the temperature sensor is fully inserted into the sensor fitting on the heater.
- Check for excessive filter duration.
- Check the water level.
- Check the water temperature with an accurate temperature thermometer. Remove the spa cover and allow the water to cool to below 108° F. Adding cool water may be necessary. Touch any button to reset the system. If the water is still hotter than the set temperature, press the blower button (if applicable) to cool the spa.
- If the Problem Recurs, test the Sensor Set.

NOTE:

A common programming mistake is overlapping filter times that may cause the spa to filter continuously.

If alternating with temperature, it may just be a temporary condition. If flashing by itself, spa is shut down. If the panel also displays "Service Req" spa is shut down. If the spa shuts down due to this error, one (or both) of the sensors are probably reading several degrees off. If the problem recurs, test the sensor set.

FREEZE CONDITION

When either sensor reads below 40°F (4°C), the system provides freeze protection. It automatically activates the pump (and the heater if necessary) to circulate the water and warm the plumbing. The equipment stays on until the sensors detect that the spa temperature has risen to within 15°F of the set temperature. The other pumps and the blower will purge for 30 seconds to 2 minutes at the end of the freeze condition. If pump 1 was turned on due to this reason alone, this message will appear for up to two minutes right after very cold water is detected.

NOTE: Internal freeze protection only functions when there is proper power running to the spa, and the control system is operational. Using an optional freeze sensor may be necessary in extreme climates to prevent plumbing damage, but will only

work properly if placed inside the spa skirt in the coldest area. All spa models are different in shape and size and have different thermal characteristics; therefore, Balboa Water Group cannot be held responsible for freeze damage to the spa's plumbing. Testing is the responsibility of the spa manufacturer and must be done to determine the best location for the freeze sensor.

SOME TROUBLESHOOTING SCENARIOS

You find out the system is in "OHH". This alone doesn't explain a lot. What led up to the "OHH" is much more important. If it's a Prestige, review the fault log carefully. Otherwise, see if the user has any additional information (for example, how long before the "OHH" was the spa panel last checked, and how hot was the water then). If the spa has cooled, see whether the problem can happen again, this time watching carefully to see if there are additional clues leading to the "OHH" (for example, other messages that appear shortly before the "OHH" happens).

You find out the system keeps showing "HFL," or is now in "LF," or is shut down due to a "dry" fault. Put the spa in test mode with the light on, so that you see the two sensor temperatures. Are they normal (within 1°F/0.5°C) when not heating? How far apart are they when heating? "HFL" happens when they are 6°F/3°C apart (4°F/2°C on 120V and other low-heater-wattage systems), see how quickly that happens after heating starts. If it's getting close to that right away, it's probably a consistent flow problem, but if it's nowhere close to the "HFL"-causing temperature difference, the flow problem may be intermittent or only occur in certain specific situations.

TEST MODE

Test modes vary for different systems and configurations. Please refer to the specific Tech Sheet applicable.

MESSAGE CODES

Refer to Tech Sheets for each system code. Or, a general set of codes for BP systems is found under the section *TP400, TP600 Message Codes* in this manual. Message codes are the same for all TP panels.

230 Volt 50 Hz - Residual Current Devices (RCD's)

A residual current device (RCD,) is the generic term for a device that monitors the current in the line conductor and the neutral conductor of a circuit in an earthed system.

In a circuit that's operating properly, the vector sum of the live and neutral current values added together will be zero. Current flowing to earth, due to a line earth fault, will return via the earth conductor, and regardless of load conditions, will be registered as a fault. This current flow will give rise to a residual current that will be detected by the device. If the residual current exceeds the rated sensitivity of the RCD, it will automatically activate a tripping of the faulty circuit.

Two Pole RCD



Typical specifications are as follows:

- Residual Current Devices (RCD's) range
- Sensitivity - from 10 to 500mA
- Voltage - 2 poles : 230V; 3/4 poles: 230/400V
- Connection capacity
- 25A: 6/10 mm² (flexible/ rigid cable)
- 40,60A: 16/25 mm²
- 80,100A: 35/50 mm²



Four Pole RCD

Wiring Checks



WIRING CHECK PRECAUTIONS

- When working in a system box always be aware that it may contain high voltage.
- Always keep your fingers and hand tools away from any wiring or circuit board when the power is on. Touching anything in these areas can result in serious injury.
- All service calls, no matter how minor, should include a complete wiring check, beginning with the house breaker.



CHECK FOR LOOSE CONNECTIONS OR DAMAGED WIRES

- Make sure the power is off before you touch any wiring.
- Once the power is off, carefully examine all wires for cuts or defects.



SYSTEM BOX WIRE GAUGE CHECK

- When inspecting the wiring for any control system, note that connections for the incoming wires are clearly labeled at the main terminal block.
- 30A service – minimum ten gauge copper wire.
- These wires must connect the house breaker box, through the local disconnect, to the main terminal block. The wiring diagram inside the system box shows the main terminal block as TB1.

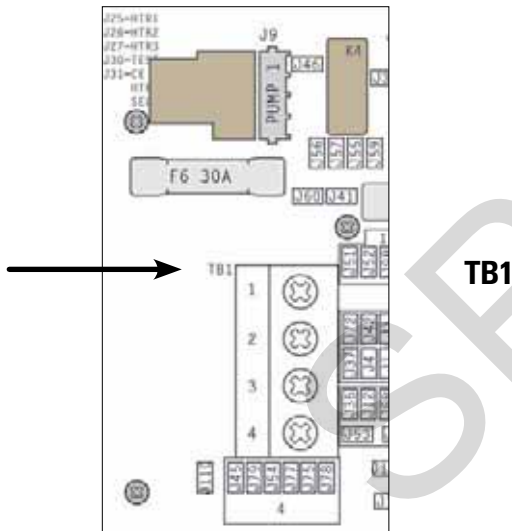

IMPORTANT -- USE OF NON-COPPER WIRE

Using non-copper wire can be dangerous, and also can be the cause of a spa's malfunction. If non-copper wire is used at any point, we do not recommend servicing the spa until an electrician replaces it with the proper gauge copper wire.

Total Ampere Rating of Power System	Minimum wire size Use Copper ONLY, with 90 ° C insulation	Ampere Rating of RCD Circuit-breaker
0 A to 16 A	#12 AWG	20
16 A to 20 A	#10 AWG	25
20 A to 24 A	#10 AWG	30
24 A to 28 A	#8 AWG	35
28 A to 32 A	#8 AWG	40

Wiring Check for RCD and Service Disconnect



IMPORTANT!

Remember, high voltage is still accessible in the house breaker box even though you have turned off the spa breaker. Keep in mind that a majority of R.C.D. tripping problems can be attributed to incorrect wiring. R.C.D. troubleshooting usually finds the problem.

RCD LINE-IN WIRING CHECK

- Locate the proper circuit breaker and turn it off.
- Remove the cover from the house breaker box. Check the main service amperage rating to the breaker box.
- From the circuit breaker, locate the brown load wire and the blue neutral wire.
- From the R.C.D. neutral bar, locate the blue load neutral, and the green ground wire.
- Be sure there are no other appliances on the spa circuit. If there are, service must be re-wired to supply the spa only.
- Make sure all three wires exit the house breaker box via conduit, routed to the R.C.D. breaker box. The brown should be connected to the R.C.D. line-in. The blue load neutral connects to the neutral in.

RCD LINE-OUT WIRING CHECK FOR 230 V DEDICATED SYSTEM

The brown wire should connect to load out, the blue wire from neutral out. All wires will exit the box via conduit routed to the spa control system.

Once you have found all wiring correctly installed, begin to check for proper voltage. If Correct Wiring is Verified, check to see if the proper RCD is installed.

- Check the label in the system box near TB1 to determine the maximum amperage draw for the system.
- Be sure the R.C.D. is rated for more amperage than the system will draw.
- For a 230 V dedicated system, a 2-pole or 4-pole R.C.D. with no load neutral is acceptable.
- For a detailed wiring checklist, please review the previous segment of this manual on proper R.C.D. wiring or the R.C.D. manufacturer's instructions.
- If the wiring is correct and the R.C.D. will not reset, then unplug the pump and try to reset the R.C.D.
- If the R.C.D. trips again, then unplug the blower and push the reset button. If the R.C.D. continues to trip, then do the same procedure for the ozone generator.
- If the R.C.D. stops tripping after you unplugged one of the spa's components, turn off the power to the spa then plug in each component except the one that tripped the R.C.D.
- Power up the system. If the R.C.D. no longer trips, then you have correctly identified the problem.
- Repair or replace the component as instructed by the spa manufacturer.
- If you have unplugged all of the spa's components and the R.C.D. still doesn't reset, then the problem is most likely a ground fault in the heater.
- Disconnect the heater, and test.

Troubleshooting Pumps, Problem & Cause

Cause	Problem	Pump motor does not start	Pump will not turn off	Pump not pumping properly	Jets not fully functioning	Low water pressure / flow	Water leakage f/ unions	No air mixed into water	Contact qualified electrician for service	Pump hums, noisy
GFCI / Fuse		X							X	
No incoming power		X							X	
Thermal overload tripped									X	
Air button, or switch on pump defective		X	X						X	
Air tube blocked, kinked, or dislodged		X	X						X	
Jets are closed				X	X				X	
Leaks / loss of prime				X					X	
Low voltage; is there proper voltage?				X					X	X
Motor burnt, flooded by water		X							X	
Open air control valves								X		
O-ring over / under tightened, pinched, improperly seated							X		X	
Pipe inlet higher than water line				X		X			X	
Pump jammed with debris		X		X		X			X	X
Pump not installed at correct level				X	X				X	
Suction cover/guard, impeller, or filter may be clogged				X	X	X			X	X
Water level too low				X	X					
Bearings bad									X	X

Acceptable Ranges for Testing Equipment

VOLTAGE CHECKLIST

All voltages specified as 120 V or 240 V, may show an acceptable variance of +/- 10%.

Voltage Ranges

Wire Combo	Voltage	+/- 10% Range
Black & Red	240 V	216 V - 264 V
Black & White	120 V	108 V - 132 V
Red & White	120 V	108 V - 132 V
Black & Green	120 V	108 V - 132 V
Red & Green	120 V	108 V - 132 V
Green & White	0 V	* *

* Depending on variables such as length of run, type of wire and temperature, small voltage readings may sometimes occur between ground and neutral.

MOTOR AMPERAGE GUIDELINES

The following ranges represent general parameters for many different motors and applications. Check the device label or with the spa manufacturer to get accurate amperage draws.

AMPERAGE DRAW RANGES

DEVICE	120 V DRAW	240 V DRAW
Pump low	2 A - 5 A	2 A - 4 A
Pump high	10 A - 14 A	8 A - 12 A
Blower	6 A - 8 A	3 A - 4 A

ACCEPTABLE HEATER AMPERAGE DRAW RANGES

Heater Type	120V Amp Draw	240V Amp Draw
5.5 kW @ 240 V	10.42 A - 12.74 A	20.83 A - 25.48 A
4 kW @ 240 V	7.58 A - 9.26 A	15.15 A - 18.52 A
1 kW @ 120 V	7.58 A - 9.26 A	---

ACCEPTABLE HEATER OHM (Ω) RANGES

Heater Type	Ohms (Ω)
5.5 kW @ 240 V	9.42 Ω - 11.52 Ω
4 kW @ 240 V	12.96 Ω - 15.84 Ω
1 kW @ 120 V	12.96 Ω - 15.84 Ω

TEMPERATURE & HIGH-LIMIT SENSOR OHM TABLE

Temp. of Sensor	Ohms (kΩ)**	Temp. of Sensor	Ohms (kΩ)**
40° F	76.686 kΩ	90° F	22.117 kΩ
45° F	67.112 kΩ	100° F	17.636 kΩ
50° F	58.858 kΩ	105° F	15.788 kΩ
60° F	45.550 kΩ	110° F	14.158 kΩ
70° F	35.533 kΩ	115° F	12.716 kΩ
80° F	27.931 kΩ	120° F	11.439 kΩ

**Note: 1 kΩ = 1000 Ω :
kΩ may vary +/- 10% depending on the accuracy of the thermometer and meter used.

HEATER MATRIX

Heater Type	Ohms	120V Amp Draw	120V Watts	240V Amp Draw	240V Watts	230V Amp Draw	230V Watts
5.5Kw @ 240V	10.472	11.458	1.37Kw	22.916	5.5Kw	21.961	5.05Kw
5.2Kw @ 240V	11.076	10.834	1.3Kw	21.666	5.2Kw	20.765	4.8Kw
4Kw @ 240V	14.4	8.333	1Kw	16.666	4Kw	15.972	3.7Kw
3Kw @ 240V	19.2	6.25	750W	12.5	3Kw	11.979	2.8Kw
2Kw @ 240V	28.8	4.166	500W	8.333	2Kw	7.986	1.8Kw
1Kw @ 120V	14.4	8.333	1Kw	N/A	N/A	N/A	N/A

Fuses: Devices, Locations, and Values

Fuses:

BP500 series (UL),

BP600 Series (CE)

Fuse	Fuse Current Rating	Protects device on output #	Device - depending on system set up	
F2	3A 250VAC	J22	Ozonator	
F3	10A 250VAC	J14 (option)	Blower fuse only. Jumped out for Pump 2.	
F4	3A 250VAC	J15	Spa Light	
F5	30A, Class G, 250V	All, Except Heater	Input power (Line 1)	
F6	0.3A, Slo-Blo	BP500 (UL)	120VAC Transformer Input	
F6	0.15A, Slo-Blo	BP600 (CE)	230VAC Transformer Input	

Fuses:

BP2000 series (UL),

BP2100 series (CE)

Fuse	Fuse Current Rating	Protects device on output #	Device - depending on system set up	
F2	10A 250VAC	J32, J21	Ozonator, Circ Pump	
F3	0.3A Slo-Blo	BP2000 (UL)	120VAC Transformer Input	
F3	0.125A Slo-Blo	BP2100 (CE)	230VAC Transformer Input	
F4	3A Slo-Blo	J15	Spa Light	
F6	30A	J9, J33	Pump 1, AV (Audio), .250 spades	
F7	10A	J14	Blower fuse only. Jumped out for Pump 2.	
F8	30A	Typically J14	Floating - Typically J14 (P2, Blower, etc.)	
F1	30A	J1	Pump 2, Pump 3, Microsilks, etc.	On Expander Board
	Fuse	BWG Part Number		
	30A	30136		
	10A	30122		
	3A Slo-Blo	20600		
	0.3A Slo-Blo	21581		
	0.15A Slo-Blo	26281		
	0.125A Slo-Blo	26397		

Troubleshooting Using Resistance - Ohm's Law

OHM'S LAW

The direct current flowing in a conductor is directly proportional to the potential difference between its ends. It is usually formulated as $V=IR$, where V is the potential difference, or voltage, I is the current, and R is the resistance of the conductor.

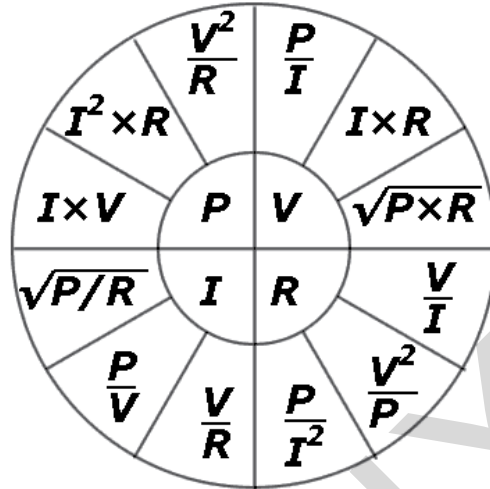

Quantity	Symbol	Unit of Measurement	Unit Abbreviation
Current	I	Ampere ("Amp")	A
Voltage	E or V	Volt	V
Resistance	R	Ohm	Ω

CONTINUITY



Testing a Fuse: Continuity

NOTE: THERE ARE NO SERVICEABLE PARTS ON THE PCB.

THE PREFERRED WAY TO CHECK FOR FUSE CONTINUITY IS WITH THE FUSES REMOVED FROM THE CIRCUIT.



TESTING A FUSE: CHECK CONTINUITY WITH THE FUSE REMOVED



A FUSE WITH THE METER READING "GOOD"



A FUSE WITH THE METER READING "BAD"

FUSES USED ON BP SPA SYSTEMS	
Fuse	BWG Part Number
30A	30136
10A	30122
3A Slo-Blo	20600
0.3A Slo-Blo	21581
0.15A Slo-Blo	26281
0.125A Slo-Blo	26397

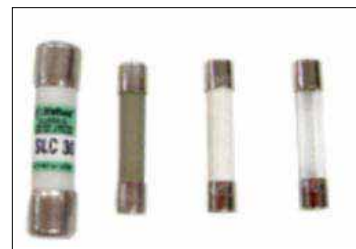

Troubleshooting Heater Resistance



TEST IS WITH POWER OFF

TROUBLESHOOTING HEATER RESISTANCE

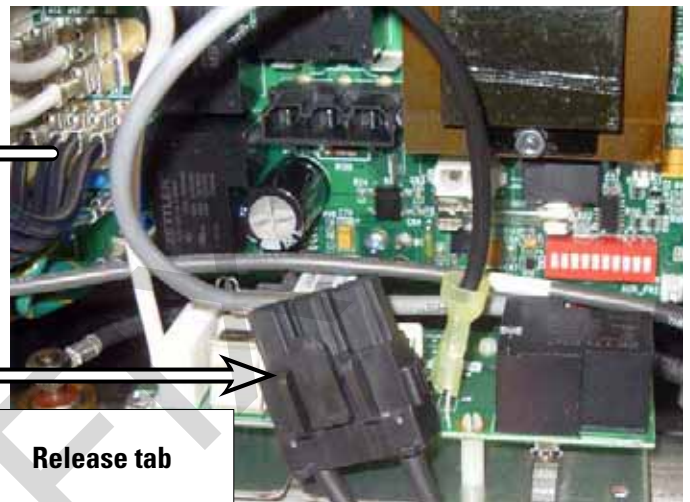

Locate the heater connector.

Disconnect the connector by depressing the tab.

Pull the connector straight out.



Place the meter probes on the heater terminals.

ACCEPTABLE HEATER OHM (Ω) RANGES

Heater Type	Ohms (Ω)
5.5 kW @ 240 V	9.42 Ω -11.52 Ω
4 kW @ 240 V	12.96 Ω -15.84 Ω
1 kW @ 120 V	12.96 Ω - 15.84 Ω

**Note: 1 k Ω = 1000 Ω :

k Ω may vary +/- 10% depending on the accuracy of the meter used.

Troubleshooting Heater Posts Resistance to Heater Housing



TEST IS WITH POWER OFF

TROUBLESHOOTING HEATER POSTS RESISTANCE TO HEATER HOUSING

VERIFY THAT THERE IS NO HEATER "LEAKAGE"

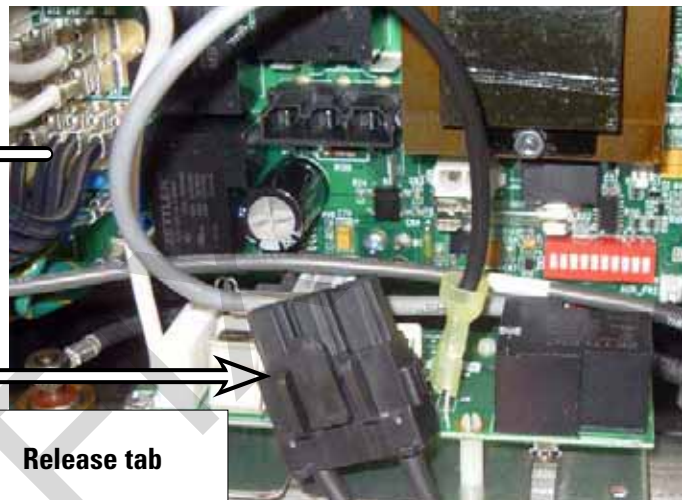

Locate the heater connector.

Disconnect the connector by depressing the tab.

Pull the connector straight out.



Measure resistance from a heater post to the heater housing

Verify there is NO continuity from the heater post to the heater housing or heater current collector connection. The meter reading shown is OL, indicating infinite resistance.



Verify there is NO continuity from the heater post to the ground/earth. On the resistance scale, the a digital meter should read OL (indicating infinite resistance).

Troubleshooting with Voltage



IMPORTANT!

**BEFORE TESTING A SPA CONTROL SYSTEM FOR VOLTAGE OR AMPERAGE, BE SURE OF THE FOLLOWING DANGERS:
HIGH AND LOW VOLTAGE CAN KILL.**

QUALIFIED TECHNICIANS SHOULD BE PERFORMING THESE TESTS



WHEN TESTING VOLTAGE

OR



WHEN TESTING AMPERAGE

OBSERVE SAFETY AT ALL TIMES

Verifying Incoming Voltage at the Terminal Block - BP2100 & BP600



CAUTION - TEST IS WITH POWER ON

VERIFYING INCOMING VOLTAGE AT THE TERMINAL BLOCK.



**Brown to Blue Wires
on a 230V BP2100 System**



**Brown to Blue Wires
on a 230V BP600 System**

**NOTE THAT BROWN AND BLUE WIRE ORIENTATION IS
DIFFERENT ON THE TWO SYSTEMS SHOWN.**

Testing Pump Fuses for Damage with Voltage On - BP2100



CAUTION - TEST IS WITH POWER ON

THERE ARE THREE 30A PUMP FUSES IN THE BP2100G1 SPA CONTROL SYSTEM.

F6 AND F8 ARE ON THE MAIN BOARD. F1 IS LOCATED ON THE EXPANDER BOARD.

TEST THE VOLTAGE FROM THE LEFT SIDE OF THE FUSE

TEST THE VOLTAGE FROM THE RIGHT SIDE OF THE FUSE



F6 TO TB1 BLUE

230V on each side indicates a good fuse

230V on one side and 0V on the other side indicates a bad fuse

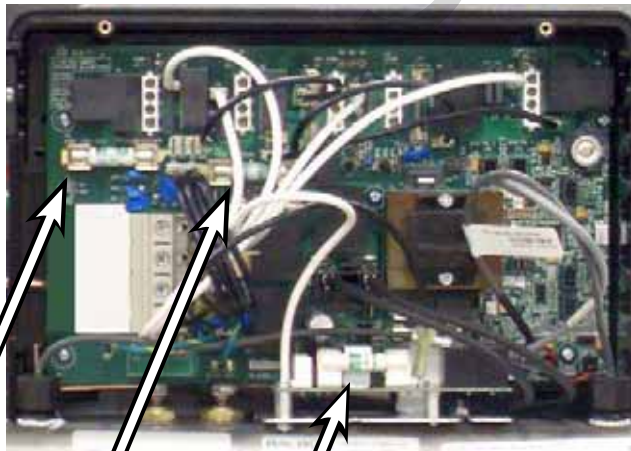

F6

F8

F1

Then continue measuring the other two fuses: F8, F1

Testing Heater Voltage - All BP Systems

⚠ CAUTION - TEST IS WITH POWER ON.

Testing at the heater terminal verifies that there is not a broken line to the heater. It may also indicate problems that may not be apparent visually, such as corrosion or a damaged heater terminal post.

However, before you do test, read on...



⚠ AVOID TOUCHING THE HEATER ASSEMBLY WHILE PERFORMING THIS TEST.

THE HEATER IS ATTACHED TO GROUND.

Many people use probes to test live heater voltages from TB1 to a heater post, or across both posts.

DON'T.

There is danger in measuring voltages across heater posts. Some of the common problems in testing spa systems are that:

1. The area is often tight and confined.
2. The area is often not well lit.
3. Spa control systems are usually placed at near ground level, which makes measuring with meter probes awkward or difficult. The probes may have a tendency to slip or not touch the designated point of test. If a probe slips and simultaneously contacts a hot (230V) post and ground, severe arcing will occur. **DEATH OR SEVERE INJURY CAN OCCUR.**

(continued on next page)

WRONG!

DO NOT MEASURE ACROSS HEATER TERMINALS



A Safer Way to Test Heater Voltages

Equipment needed:

- Insulated clamps for your voltmeter probes

Suggested attire:

- Safety glasses
- Rubber gloves (when measuring live electrical wires)

1. Turn the power OFF to the spa control system.
2. Set voltmeter for AC high voltage reading. Set clamps onto terminals securely. Be sure that both insulated boots *fully cover the clamps*. Be sure that both clamps are not touching each other and that they are not making contact with anything below the insulating material on the terminal. (See photo below.)
3. Turn on power to the spa. Do not disturb the voltmeter or clamps until the power is turned off.
4. With the system operating and the panel display set for the need for heat, verify the voltage at the heater posts. On a 230V system, the reading will be near 230V. (Allow for +/- 10% variance.)
5. When finished with testing, turn the power off before removing the clamps from the terminal posts.



Be sure that both clamps are not making contact with anything below the insulating material on the terminal (arrows).

Note: Black boot removed below to show detail.

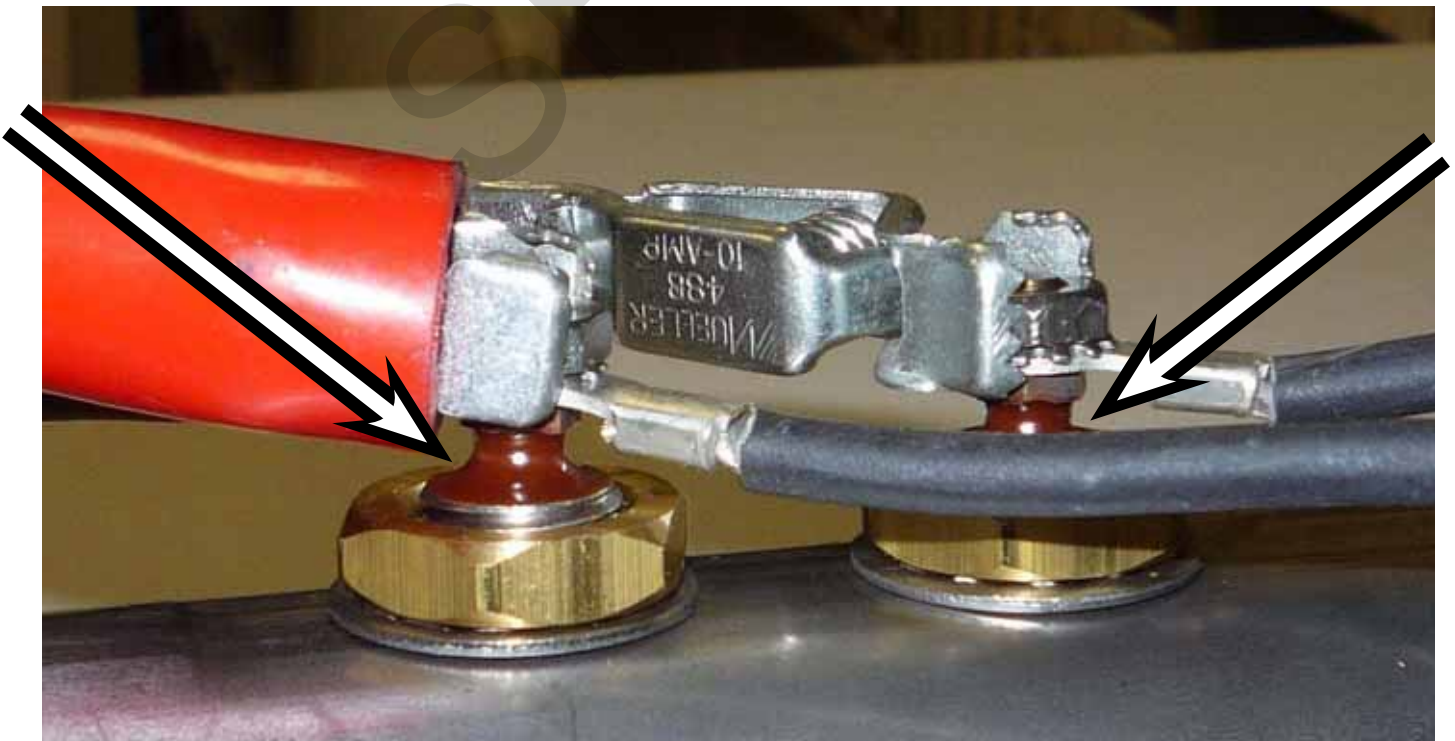

Testing Pump Fuses for Damage with Voltage On - BP600

Due to the design of the BP500, the upper Logic board must be moved out of the way to test most of the power board fuses.

To gain access to the power board:

1. Power down the system.
2. Remove the sensor wires from the logic board. Be sure to depress the release tab on the sensor connector. Do not pull on the wire.
3. Remove the four corner retaining screws.
4. Place the Logic board out of the way of any metal or points of system voltage or grounding areas once the system is powered up.

Note: One consideration to isolate the logic board from the metal chassis is to place a non-conductive material separating the components (below).

Also, if you must move the components around for testing, add or remove sensors or wires, take a few moments to power down the system.

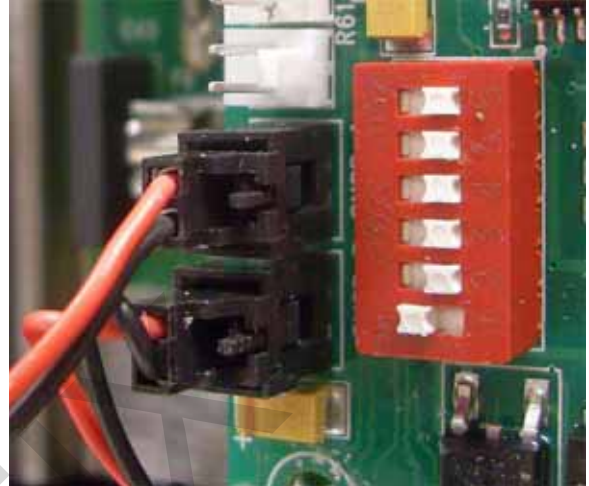

Sensor Location BP500, on Logic Board



**Depress sensor tab
when removing**

For safety, an antistatic bag, a piece of cardboard (as shown here), or any other insulator should be used to separate the chassis ground from the logic board.

The Logic board must not be in contact with any hot spots, chassis ground, or floor of the spa area when the system is powered up for testing. Be especially careful if the surrounding floor area is wet.

Testing Heater Amperage



CAUTION - TEST IS WITH POWER ON

PLACE CLAMP AROUND ONE HEATER WIRE, AND THEN THE OTHER WIRE.



AMPERAGE HEATER TEST BP600



AMPERAGE HEATER TEST BP2100G1

SPAFIX

Testing Low Speed and High Speed at the AMP Connector

TESTING LOW SPEED AND HIGH SPEED AT THE AMP CONNECTOR

! CAUTION - TEST IS WITH POWER ON

Board Connector Key

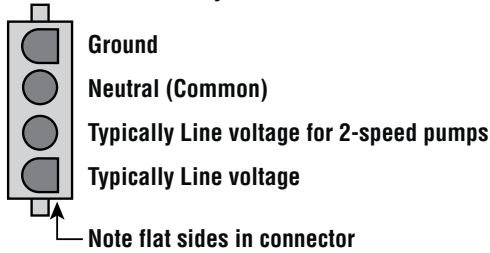

**WITH THE PUMP LOW SPEED ON,
TAKE A VOLTAGE READING AT THE
AMP RECEPTACLE ON THE PCB**

**THIS WOULD TYPICALLY SHOW LOW
SPEED VOLTAGE FOR PUMP ONE. (230V)**

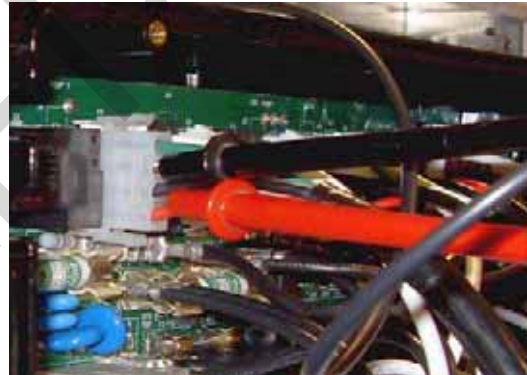

**WITH THE PUMP HIGH SPEED ON,
TAKE A VOLTAGE READING AT THE
AMP RECEPTACLE ON THE PCB**

**THIS WOULD TYPICALLY SHOW HIGH
SPEED VOLTAGE FOR PUMP ONE. (230V)**



**Note: These are typical settings only.
Voltages may be different depending
on the configuration that the system is
set to. See the system's Tech Sheet for
more information.**



PUMP 1 AMP CORD

Testing the Sensor Set

1. Begin the diagnosis with the power off. Check sensor wires for cracks or damage that may indicate the presence of a rodent.
2. Inspect the connections of both sensors on the circuit board. The plugs must be clean.
3. If the sensors are not totally failing but are showing excessive (2° F/1.0 °C or more) difference between the two sensors when not heating (a possible cause of Sn/SnS/SENSOR SYNC, HL/HFL/HTR FLOW LOW, and LF/LOW/FLOW/messages), do the following:
 - Note which sensor is reading consistently higher (A vs B or T vs H).
4. Unplug the two sensors from the circuit board and exchange their positions (i.e., plug the one that was in the "Sen. A" jack into the "Sen. B" jack and vice versa).

Note: When removing a sensor wire from the board, depress the tab. **Do not pull on the wire.**
5. Press a panel button if any "stray" faults appeared during the process. (Stray faults are normal when sensors are unplugged then plugged back in while the system is running.)
6. Within a minute or so, see if the same or other sensor is now reading consistently higher:
 - If the same sensor (A vs B or T vs H) is reading higher after the sensor interchange, the problem is on the circuit board. Replace the circuit board.
 - If the opposite sensor is now reading higher, the problem is with the sensor(s). Replace the sensor set.

** If you wait more than 2 minutes after plugging the sensors back in, heating may start (even outside a filter in Economy or Sleep mode) due to a stray Cd/CLd/COLD WATER condition usually detected when sensors are being plugged in while the system is running.*

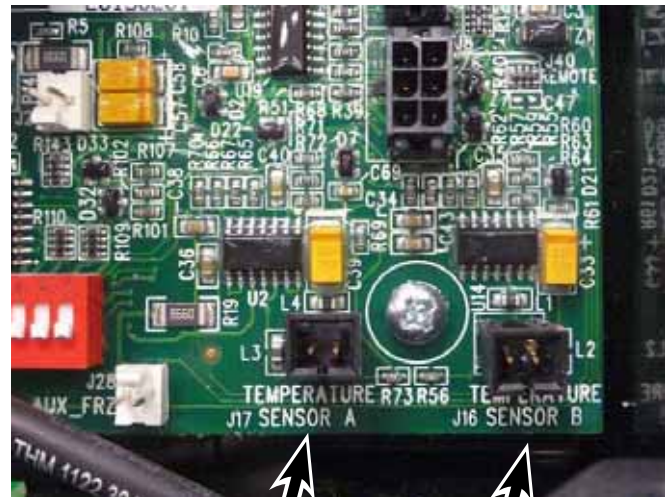
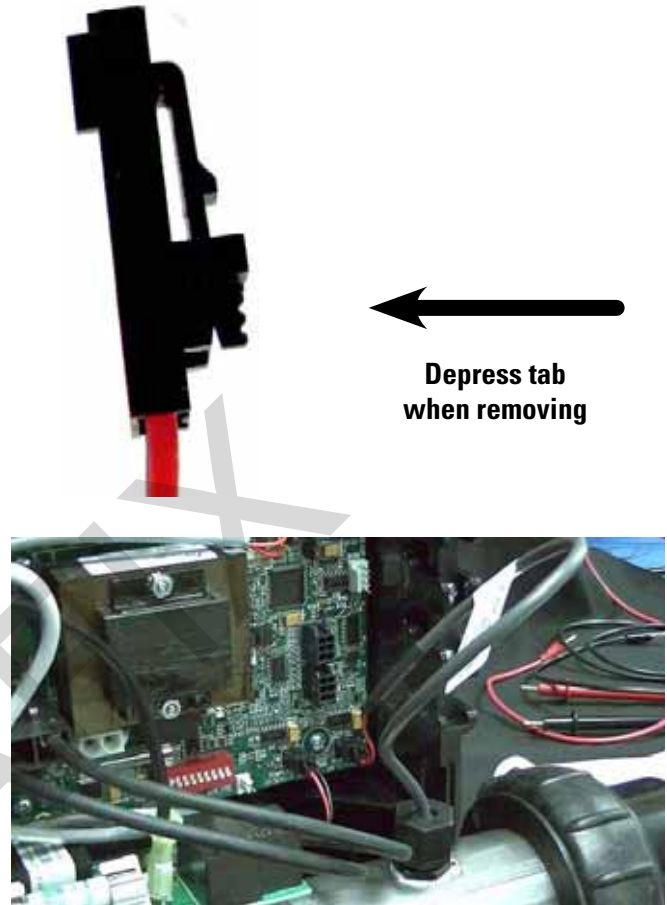

**TEMPERATURE SENSORS LOCATION
(WIRES REMOVED)**

Testing the Sensor Set (cont.)

7. If there is a message indicating an open or faulty sensor:
 - Unplug the sensor set (but leave the original sensors in the heater) and plug in the test sensor set. Put both sensors into the same cup of warm water (ideally above the set temperature, so the spa won't try to heat during this test, as there is no heater protection during this test) and verify that they read the same temperature (within 1°F/0.5°C).
 - If the problem is solved, replace the sensor set. If the problem is not solved, do not replace the sensor set.
 - Plug in the original sensor set to verify that there is not a connection problem.
 - If the problem continues after following the above steps, then replace the circuit board.

TESTING SENSOR PINS

ALWAYS TURN THE POWER OFF WHEN PLUGGING AND UNPLUGGING!

Sensor Pins: At times, a protective coating may on accident coat the sensor pins during manufacturing. Those pins may need to be scraped and the sensors plugged back in.

Tip: If one sensor (A or B) seems to be having problems, swap the cables of sensor A with sensor B.

If the problem stays with the same sensor (according to topside messages) it's a board problem; if the problem moves to the other sensor it's a sensor problem.

M-7 Replacement Sensor

M-7 REPLACEMENT SENSOR

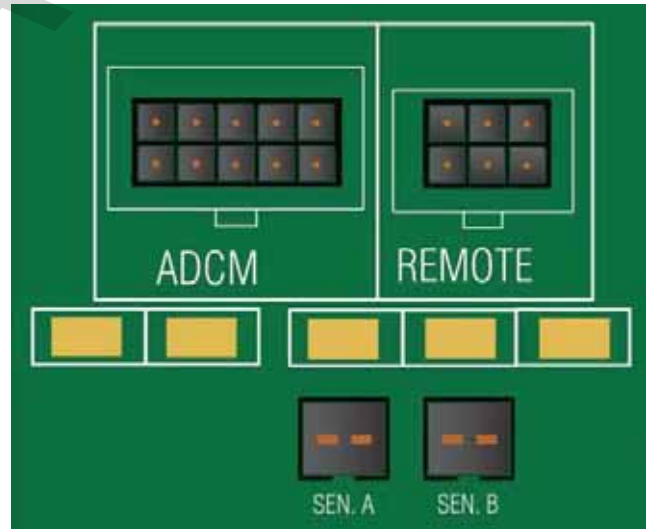
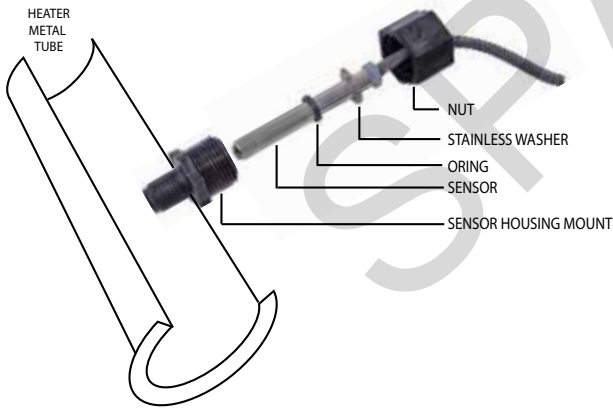

(Sample Board Shown)

Component Failure and Replacement Testing – Software Setups and Test Mode

All BP systems have the capability for Test Mode. Test Mode is used when changing setup configurations through the panel, which also means that wiring changes may be necessary. (See the specific spa control system Tech Sheet for more details.)

Note: Although Test Mode allows access to certain utility features, most Utilities are available without entering Test Mode. A/B Sensor Temperatures and Fault Log information are presented here since they appear on the Test menu screen (see below).

**DANGER! HIGH VOLTAGE WILL BE ACCESSIBLE!
SERVICE TECHNICIAN ONLY!**

TEST MENU ACCESS (S1, SWITCH 1 ON)

SOFTWARE SETUPS

Under the TEST Menu, the Setup screen will allow changing the Setup from 1 to any number established by the manufacturer. Changing the Setup may require wiring changes as well.

1. While the system is running, move DIP Switch 1 (on S1 on the Main circuit board) to ON.
2. The system will enter Test Mode. On the home screen (below) will appear the word TEST.
3. Change the setup to the desired setup configuration number (depending on DIP switch or wires changes, if any).
[\(Test Mode On\) Test > Setup](#)
4. Moving DIP Switch 1 to OFF will exit Test Mode

The Control System is in Test Mode if 102°T appears. (In this case °F or °C is replaced by °T.)

OTHER TEST MODE FEATURES:

A/B TEMPS (A/B SENSOR TEMPERATURES)

When this is set to On, the temperature display will alternate to display temperature from Sensor A and Sensor B in the heater.

FALT LOG (FAULT LOG)

The Fault Log is a record of the last 24 faults that can be reviewed by a service tech.

DEMO (DEMO MODE)

Demo Mode is not always enabled, so it may not appear. This is designed to operate several devices in a sequence in order to demonstrate the various features of a particular hot tub.

TIME OUTS

Used only by the manufacturer for specific tests.

TEMP LIMIT

Used only by the manufacturer for specific tests.

VIEWING CONFIGURATION SETTINGS

There are times when a technician may want to view the configuration settings (or, config. setup) before working on a system. View the configurations in the following way:

- TP900/TP800 panels:** System Information > Current Setup
- TP600/TP400 panels:** UTIL > INFO > SETP (Standard Menus)
- TP600/TP400 panels with Simplified Menus** can only access the configuration setup when in test mode.

Note: In the event that a panel stops operating, a good working panel plugged into the system will reveal the config. settings as they are held in memory.

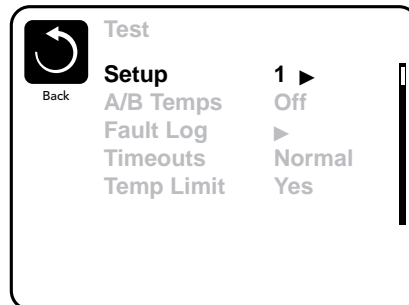
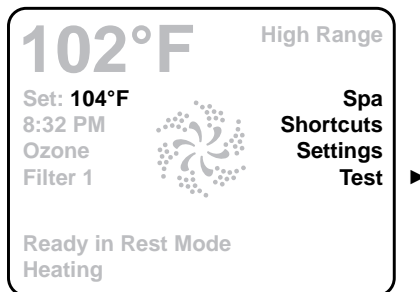
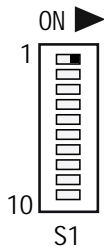

Setup Changes with DIP Switch 1 ON - Using a TP600 or TP400 Panel

For complete variations of equipment configurations and setups, the latest Tech Sheet should be obtained on the system you're working on. The information for setup changes is included here in the event you have wiring diagrams available, and to facilitate a better understanding of how setup changes are made.

Note: All TP panels can be used with all BP systems. The setup change process below uses a BP600 logic board for illustration. A BP2100 board setup is shown on the following pages.

READ AND UNDERSTAND THESE INSTRUCTIONS BEFORE BEGINNING THIS PROCESS.

Know the Setup Number you want before you power up the spa and wait to power up the spa until you're ready to change the Setup Number.

The system must be in Test Mode, so move Switch 1 to the ON position. The Test Menu will then be available. Power up the spa, and press any button once to Link the panel. (Note: Switch 1 can be moved to the ON position immediately after power-up, if preferred - **Danger! High Voltage will be present!**) You will have 1 minute to complete the setup change after you manually exit Priming Mode. (Once familiar with the process, the Setup change should take less than 15 seconds.)

As soon as Switch #1 is placed in the ON position, The temperature will show "T" after it instead of F or C, indicating the System is in Test Mode

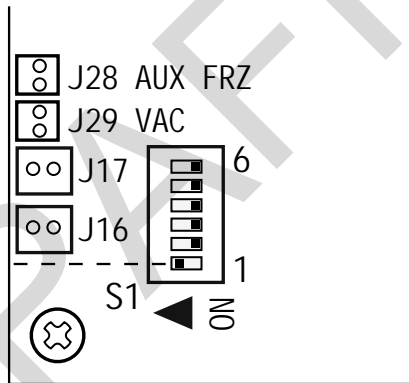

BP600 BOARD SETUP SWITCH



When the panel displays RUN PMPS PURG AIR, press any Temperature button ONCE to exit Priming Mode. You should see "---T" where the T indicates the system is in Test Mode.

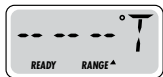

Continued on Next Page.

Setup Changes with DIP Switch 1 ON - Using a TP600 or TP400 Panel (cont.)

Again, you will have 1 minute to complete the setup change after you manually exit Priming Mode.

Immediately after exiting Priming Mode, press this sequence of buttons: Warm*, Light, Warm, Warm, Warm, Warm. Continue to press Warm until the display shows the Setup Number (S-01, S-02, etc.) you want to switch to. When the correct setup number is showing, press Light once, and the system will reset, using the newly-selected Setup from that point on.

Move DIP Switch 1 to the OFF position to take the spa out of Test Mode. °F or °C will replace °T.

Using a permanent marker, write the Setup number on the Setup label mounted inside the system lid (right). This is very important to any service person in the future who may need to replace a circuit board or system and needs to change the Setup on a replacement part while in the field.

NOTE: Changing the Setup may require wiring changes as well - refer to the wiring diagram or wiring diagram addendum.

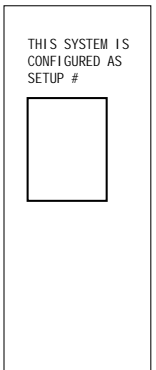

Key

- Indicates Flashing or Changing Segment
- Indicates Alternating or Progressive Message - every 1/2 second
- ⌋ A temperature button, used for "Action"
- ☀ Light or dedicated "Choose" button, depending on control panel configuration
- Waiting time - varies depending on function

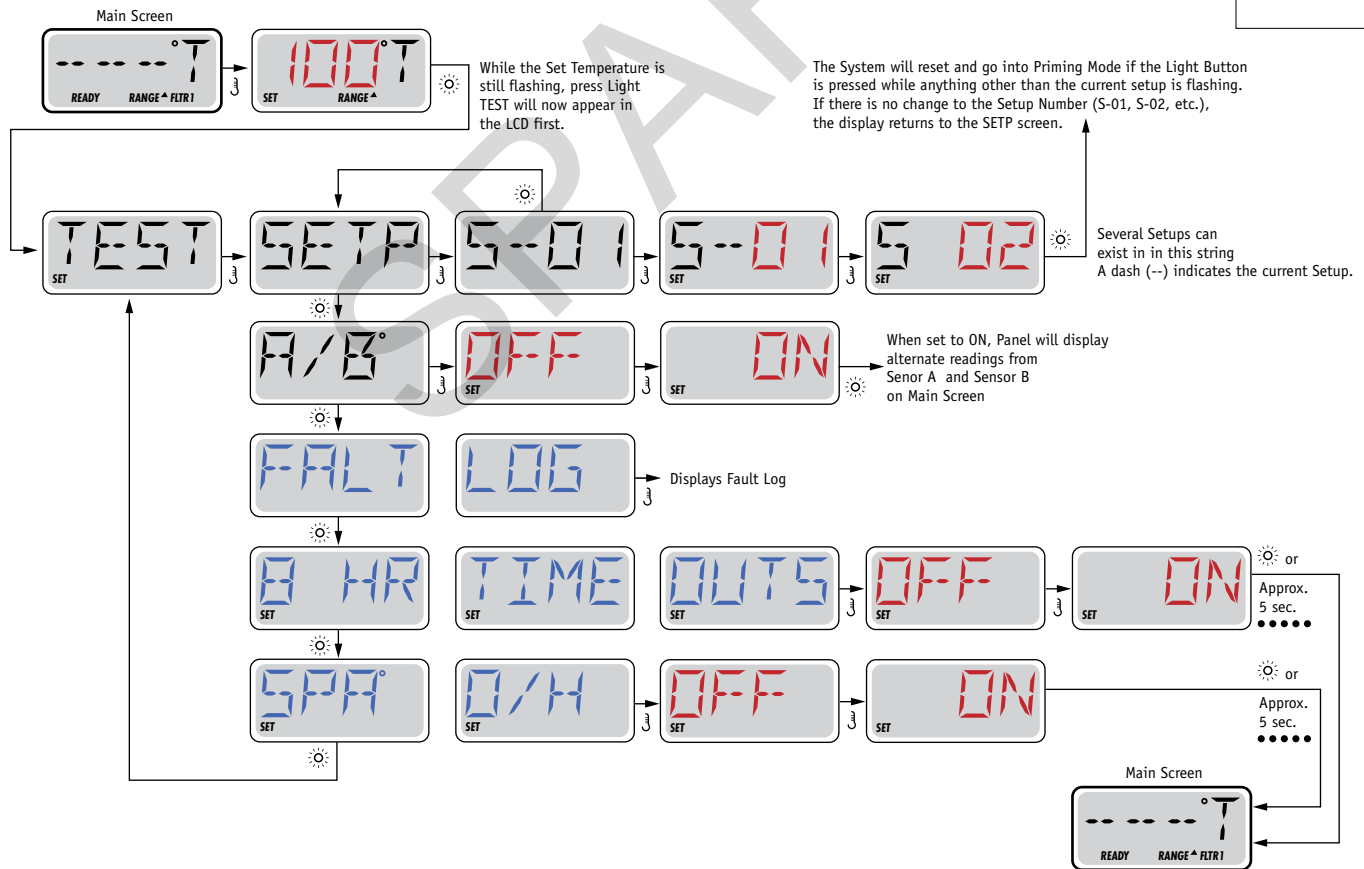

*If the Control Panel does not have a Warm (Up) button, but rather a single Temp button, use the Temp button in place of the Warm button in the instruction above. (The flow chart assumes a single Temperature Button.)

Setup Changes with DIP Switch 1 ON - Using a TP900 or TP800 Panel

For complete variations of equipment configurations and setups, the latest Tech Sheet should be obtained on the system you're working on. The information for setup changes is included here in the event you have wiring diagrams available, and to facilitate a better understanding of how setup changes are made.

Note: All TP panels can be used with all BP systems. The setup change process below uses a BP2100 board for illustration. A BP600 board setup is shown on the preceding pages.

TEST MENU ACCESS (S1, SWITCH 1 ON) SERVICE TECHNICIAN ONLY.

DANGER! HIGH VOLTAGE WILL BE ACCESSIBLE! SERVICE TECHNICIAN ONLY!

While the system is running, move DIP Switch 1 (on S1 on the Main circuit board) to ON. The system will enter Test Mode. Moving DIP Switch 1 to OFF will exit Test Mode.

SOFTWARE SETUPS (BP2100)

Under the TEST Menu, the Setup screen will allow changing the Setup from 1 to any number established by the manufacturer. Changing the Setup may require wiring changes as well.

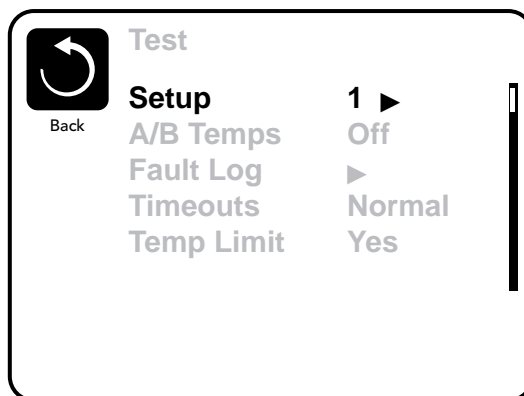
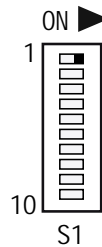
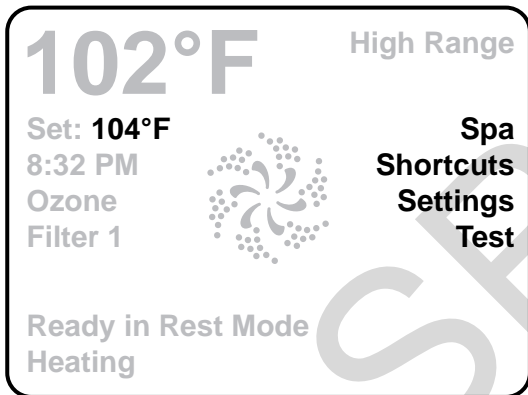
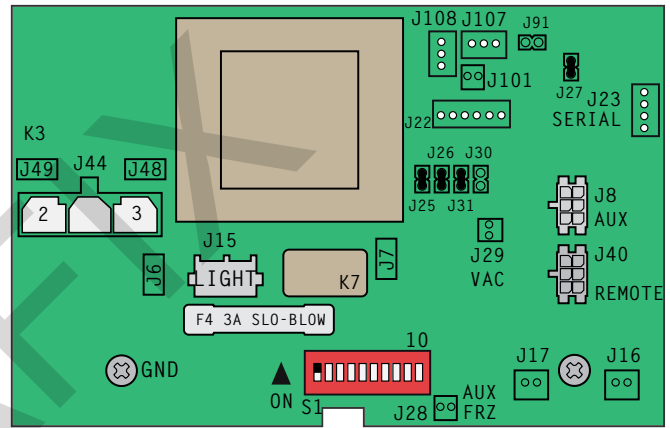

Removing the Heater Assembly from a BP Spa System

Note: Be careful when removing a heater assembly from a spa plumbing system. Water may splash out under pressure. See next page for more illustrations.

Water under pressure in the plumbing may splash out, and onto the system's electronic board. Do not remove the system door until the water has been drained from the heater assembly housed in the system.

1. Turn off the main power.
2. Close off the slice valves (or, ball valves) adjacent to the heater assembly.
3. Once the valves are closed, slowly crack the heater assembly end tubes until water flows out. If the connectors are on too tight, it may be necessary to loosen the Phillips screws that hold the connectors together. Once the water has been drained, continue.
4. Remove the system door cover.
5. **If you received the heater kit with wires** (BP2000/ BP2100 Series systems, see right):
Depress the tab on the heater connector to remove it.
6. **If you received a heater without the wire kit or if you need to replace the heater wires (see next page):**
 - a) Remove the nuts securing the heater wires to the heater assembly's terminal connectors. **Be sure to use a supporting end wrench on the lower nut.** (Upper nut is 3/8"; lower nut is 1/4".) If a lower end wrench is not used to hold the terminal in a fixed position when **removing or installing the upper nut**, excessive torque will transfer to the terminal connector and will probably damage it.
7. Replace the heater sensor wires as necessary.
8. Remove both 3/8" nuts that secure the element in place.
9. Remove the heater assembly.
10. Reverse the procedure to reinstall the heater assembly.

Note: Heater terminal nut installation is 30 - 35 in lbs. torque.

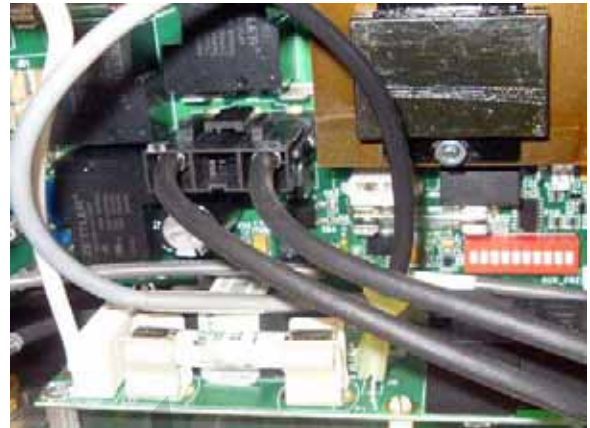

Heater Connector on BP2000/BP2100 Series

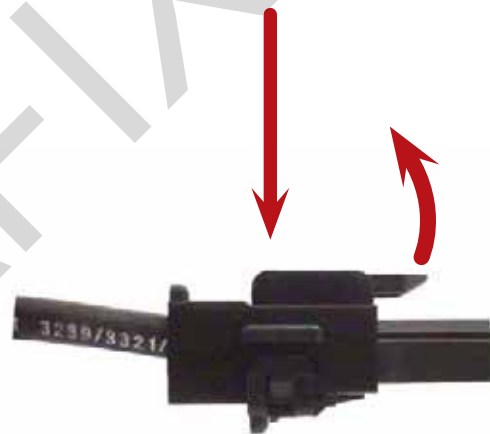

Side View: Depress Tab to Unlock Connector



Removing the Heater Assembly from a BP Spa System (cont.)

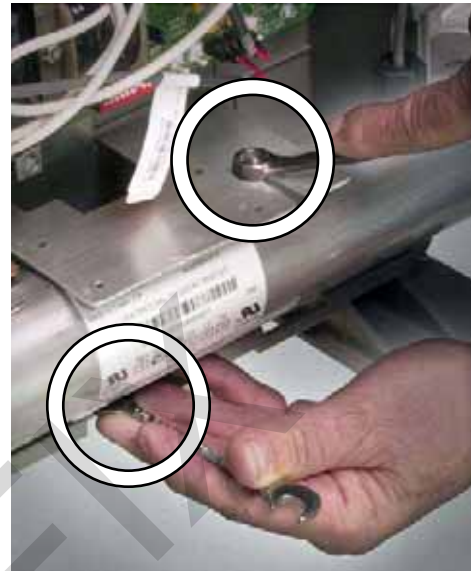
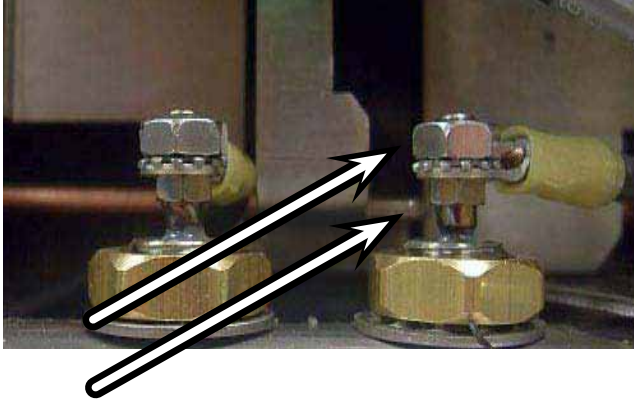

Remove both nuts that secure the element in place.

Locking nuts are in the same location on other BP models

Avoid damaging the post. Use an end wrench on the lower nut to reinforce the post when removing the upper nut.

Heater Wires on a BP500/BP600 Series system are connected to the lower Power Board.

The Logic Board must be removed to access and remove the heater wires, shown in red.

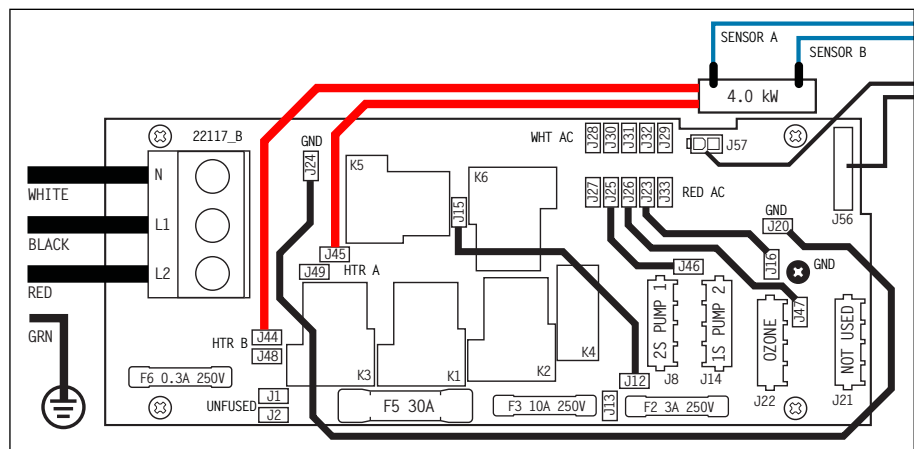

Remove and Replace a System Circuit Board (cont.)

INSTALLING A SYSTEM CIRCUIT BOARD

When reinstalling the board:

- Torque main board hold down screws to 8-10 in/lbs. Do not over tighten as damage to the board may result.
- Reconnect all wires and slip-on connectors.
- Restore power to the spa at the main breaker.
- Test to make sure all functions work correctly.

COMPATIBILITY ON DUAL BOARD CONTROL SYSTEMS

System BP600 has two boards: a power board and logic board. If one board is found to be defective and is replaced with a newer revision board, it will still be compatible with the other, older system board.

BP2100 board screw locations

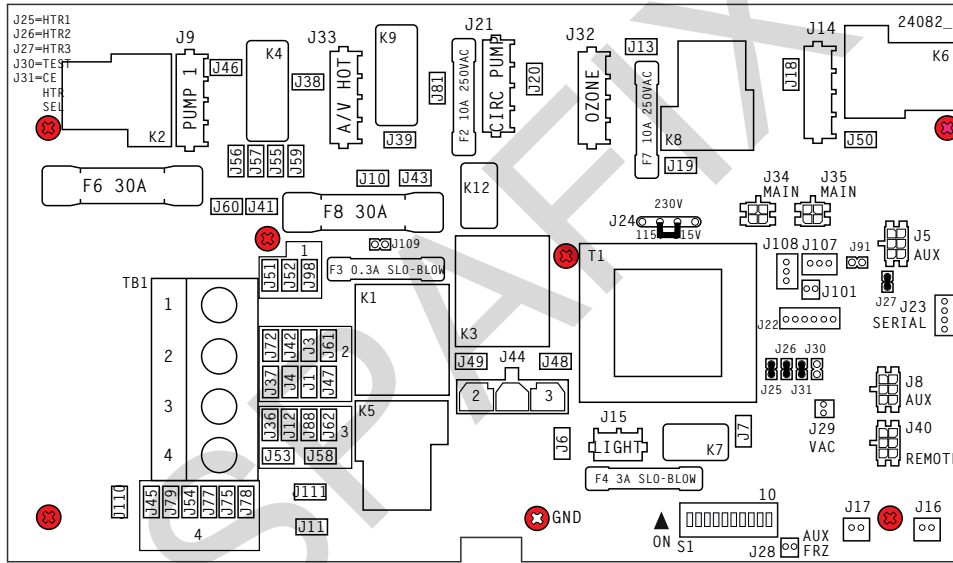

BP2100 board without wires



Remove and Replace a System Circuit Board

IMPORTANT!

BE SURE TO TURN THE POWER OFF BEFORE REPLACING ANY COMPONENT, ESPECIALLY A CIRCUIT BOARD.

IMPORTANT!

DO NOT REMOVE AND REPLACE THE CIRCUIT BOARD UNLESS THE FAULT HAS POSITIVELY BEEN DETERMINED TO BE THE CIRCUIT BOARD.

REMOVING A SYSTEM CIRCUIT BOARD

- Shut OFF line power to the spa at the main circuit breaker panel. Do not attempt to service a spa without shutting off the power. Serious injury or damage may result. Consider placing a padlock on the main service disconnect box while working on the spa.
- Before you begin, consider labeling all wires that will be removed from the board. This may help speed up reinstallation. Other technicians prefer to take the board out with wires intact, place both defective and new board side by side on a bench, then swap wires, recheck the logic jumpers, and DIP switch for proper configuration. Whatever technique is used, a wiring diagram should always be used to ensure proper wire placement.
- Remove the sensor wire connectors at the board, and the J44 heater connector on the BP2000 Board (located to the left of the transformer). Be sure to use the release tab on the connectors; do not pull on the wires.
- Some BP spa control systems use an expander board. Removing the expander board first simplifies the process. To remove it, remove the screw, and then gently squeeze the locking flange on each standoff with needle nose pliers while lifting the board out. Some technicians, after removing the screw (and if the standoffs allow it), gently pry the board up where there's a plastic stand off. Do not use excessive force if the standoff will not yield. Do not pry up directly into the board as damage to the board may result.
- Remove the seven screws (if BP2000, see illustration).
- The board should now be free and can be removed from the system box.

Removing BP Expander Board, an Alternate Way

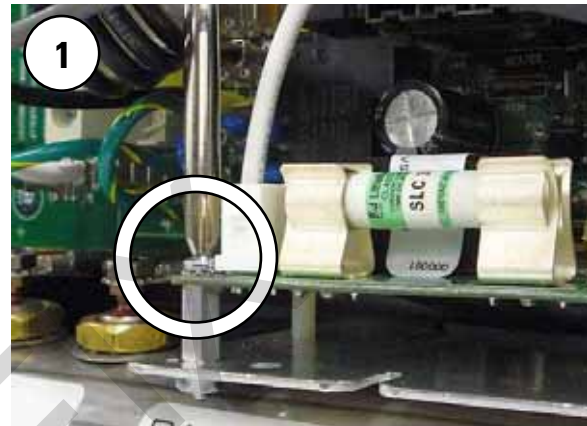

TP800, TP900 Panel Operations - The Main Screen - Navigation

SPA STATUS

Important information about spa operation can be seen quickly from the Main Screen. The most important features, including Set Temperature adjustment, can be accessed from this screen.

The actual water temperature can be seen in large text and the desired, or Set Temperature, can be selected and adjusted.

Time-of-day, Ozone operation and Filter Operation status is available, along with other messages and alerts

High Temperature Range vs. Low Temperature Range is indicated in the upper right corner

The Jets Icon in the center will spin on a TP900 if any pump is running and changes color when the heater is on. (The icon does not spin on a TP800, but still indicates pump and heater function)

A Lock icon is visible if the panel or settings are locked.

The Menu choices on the right can be selected and the screen will change to show more detailed controls or programming functions.

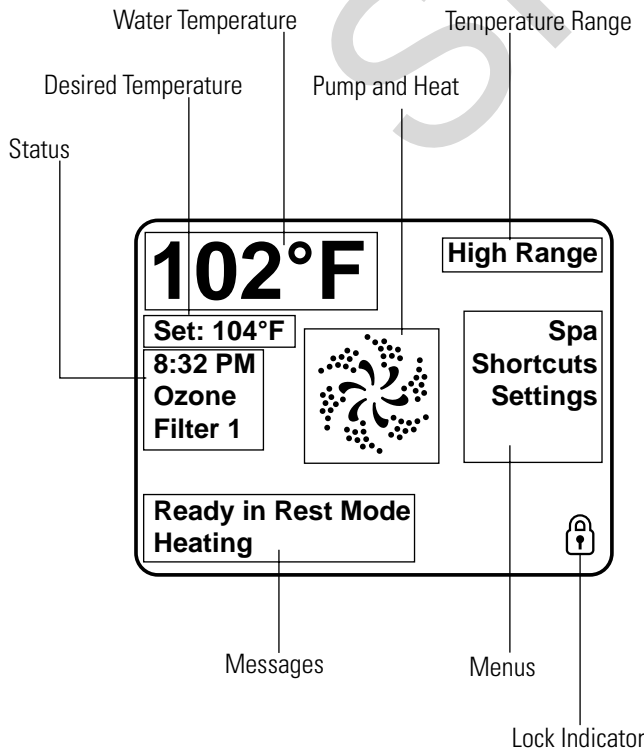

NAVIGATION

Navigating the entire menu structure is done with the 5 buttons on the control panel.

When a text item changes to white during navigation, that indicates the item is selected for action.

Operating or changing a selected item is generally done with the center or "Select" button.

The only item that can be changed on the left side of the Main Screen is the Set Temperature. Press the Left Arrow button to change the Set Temperature number to white. The Set Temperature can then be adjusted with the up and down buttons. Pressing the Select button or the Right Arrow button will save the new set temperature.

On the right side of the screen, the menu selections can be selected with the Up and Down Buttons. Use the Select Button to choose an item. Selecting one of these items will change to a different screen with additional controls.

PRESS-AND-HOLD

If an Up or Down button is pressed and held when the Set Temperature is selected, the temperature will continue to change until the button is released, or the Temperature Range limits are reached.

MESSAGES

At the bottom of the screen, messages may appear at various times. Some of these messages must be dismissed by the user.

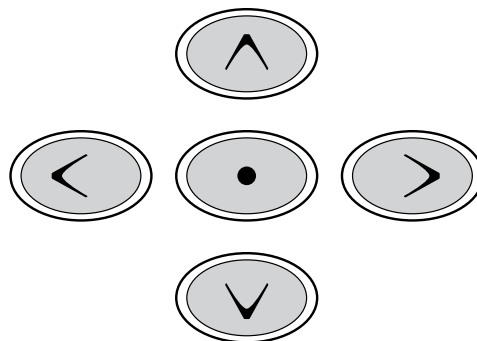

TP800, TP900 Priming Mode Start-up Sequence

PREPARATION AND FILLING

Fill the spa to its correct operating level. Be sure to open all valves and jets in the plumbing system before filling to allow as much air as possible to escape from the plumbing and the control system during the filling process.

After turning the power on at the main power panel, the top-side panel will display a splash, or startup screen.

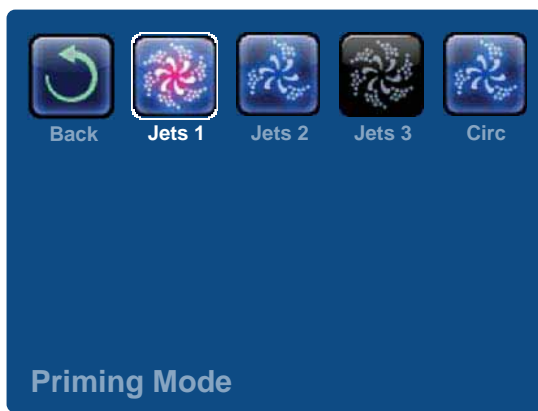

PRIMING MODE –

After the initial start-up sequence, the control will enter Priming Mode and display a Priming Mode screen. Only pump icons appear on the priming mode screen. The system will automatically return to normal heating and filtering at the end of the priming mode, which lasts 4-5 minutes.

During the priming mode, the heater is disabled to allow the priming process to be completed without the possibility of energizing the heater under low-flow or no-flow conditions. Nothing comes on automatically, but the pump(s) can be energized by selecting the “Jet” buttons.

If the spa has a Circ Pump, it can be turned on and off by pressing the “Circ Pump” button during Priming Mode. In addition, if the spa has a Circ Pump, it can be activated by pressing the dedicated “Light” button during Priming Mode when using a TP800.

Manually exit Priming Mode by pressing the “Exit” Button.

PRIMING THE PUMPS

As soon as the Priming Mode screen appears on the panel, select the “Jets 1” button once to start Pump 1 in low-speed and then again to switch to high-speed. Also, select the other pumps, to turn them on. The pumps should be running in high-speed to facilitate priming. If the pumps have not primed after 2 minutes, and water is not flowing from the jets in the spa, do not allow the pumps to continue to run. Turn off the pumps and repeat the process.

Note: Turning the power off and back on again will initiate a new pump priming session. Sometimes momentarily turning the pump off and on will help it to prime. Do not do this more than 5 times. If the pump(s) will not prime, shut off the power to the spa.

Important: A pump should not be allowed to run without priming for more than 2 minutes. Under NO circumstances should a pump be allowed to run without priming beyond the end of the 4-5 minute priming mode. Doing so may cause damage to the pump and cause the system to energize the heater and go into an overheat condition.

EXITING PRIMING MODE

You can manually exit Priming Mode by navigating to the “Back” button on the Priming Mode Screen. Note that if you do not manually exit the priming mode as described above, the priming mode will be automatically terminated after 4-5 minutes. Be sure that the pump(s) have been primed by this time.

Once the system has exited Priming Mode, the top-side panel will display the Main Screen, but the display will not show the temperature yet, as shown below. This is because the system requires approximately 1 minute of water flowing through the heater to determine the water temperature and display it.



- M0[XX] numbers are Message Codes.
- A message with an asterisk [*] can be reset from the topside panel.

TP800, TP900 Spa Behavior

BE SURE TO SET THE TIME-OF-DAY

Setting the time-of-day is important for determining filtration times and other background features. "Set Time" will appear on the display if no time-of-day is set in the memory.

On the Settings Screen, select the Time-of-Day line. On the Time-of-Day screen, simply navigate right and left to select the Hour, Minutes, AM/PM and 12/24 Hour segments. Use the Up and Down Buttons to make changes.

SAVING SETTINGS

The Time-of-Day screen is a simple, editable screen that illustrates a feature of the control that applies to all other editable screens as well.

When changes are made, the icon to go "Back" changes to "Save" and a new icon for "Cancel" appears under the Save icon. Navigating to the left will highlight the Save icon, and navigating down from there will allow the user to cancel the pending change. Pressing the "Select" button will save or cancel the changes and go back to the previous screen.

NOTE: If power is interrupted to the system, Time-of-Day will be maintained for several days.

PUMPS

On the Spa Screen, select a "Jets" button once to turn the pump on or off, and to shift between low- and high-speeds if equipped. If left running, the pump will turn off after a time-out period. The pump 1 low-speed will time out after 30 minutes. The high-speed will time-out after 15 minutes.

On non-circ systems, the low-speed of pump 1 runs when the blower or any other pump is on. If the spa is in Ready Mode, Pump 1 low may also activate for at least 1 minute every 30 minutes to detect the spa temperature (polling) and then to heat to the set temperature if needed. When the low-speed turns on automatically, it cannot be deactivated from the panel, however the high speed may be started.

CIRCULATION PUMP MODES

Some spas may be manufactured with Circ Pump settings that allow programming filtration cycle duration. Some circ Modes are pre-programmed to operate 24 hours a day and are not programmable.

If your system is equipped with a circ pump, it may be configured to work in one of three different ways:

1. The circ pump operates continuously (24 hours) with the exception of turning off for 30 minutes at a time when the water temperature reaches 3°F (1.5°C) above the set temperature (most likely to happen in very hot climates).
2. The circ pump stays on continuously, regardless of water temperature.
3. A programmable circ pump will come on when the system is checking temperature (polling), during filter cycles, during freeze conditions, or when another pump is on.
 - The specific Circulation Mode that is used has been determined by the Manufacturer and cannot be changed in the field.
 - Other device options may be available, like Blower, Light, Mist, etc.

FILTRATION AND OZONE

On non-circ systems, Pump 1 low and the ozone generator will run during filtration. On circ systems, the ozone will generally run with the circ pump, but can be limited to filtration cycles. The system is factory-programmed with one filter cycle that will run in the evening (assuming the time-of-day is properly set) when energy rates are often lower. The filter time and duration are programmable.

A second filter cycle can be enabled as needed.

At the start of each filter cycle, the water devices like blower, mist device (if these exist) and other pumps will run briefly to purge the plumbing to maintain good water quality.

FREEZE PROTECTION

If the temperature sensors within the heater detect a low enough temperature, then the water devices automatically activate to provide freeze protection. The water devices will run either continuously or periodically depending on conditions.

In colder climates, an optional additional freeze sensor may be added to protect against freeze conditions that may not be sensed by the standard sensors. Auxiliary freeze sensor protection acts similarly except with the temperature thresholds determined by the switch. See your dealer for details.

TP800, TP900 Adjusting Filtration

CLEANUP CYCLE (OPTIONAL)

When a pump or blower is turned on by a button press, a clean-up cycle begins 30 minutes after the pump or blower is turned off or times out. The pump and the ozone generator will run for 30 minutes or more, depending on the system. On some systems, you can change this setting. (See the Preferences section.)

MAIN FILTRATION

Using the same navigation and adjustment as Setting the Time, Filter Cycles are set using a start time and a duration. Each setting can be adjusted in 15-minute increments. The panel calculates the end time and displays it automatically.

FILTER CYCLE 2 - OPTIONAL FILTRATION

Filter Cycle 2 is OFF by default.

Simply navigate to the Filter Cycle 2 line by pressing the Right Navigation Button, and when "NO" is highlighted, press Up or Down to toggle Filter Cycle 2 on and off. When Filter Cycle 2 is ON, it can be adjusted in the same manner as Filter Cycle 1 by navigating to the right.

It is possible to overlap Filter Cycle 1 and Filter Cycle 2, which will shorten overall filtration by the overlap amount.

PURGE CYCLES

In order to maintain sanitary conditions, as well as protect against freezing, secondary water devices will purge water from their respective plumbing by running briefly at the beginning of each filter cycle.

If the Filter Cycle 1 duration is set for 24 hours, enabling Filter Cycle 2 will initiate a purge when Filter Cycle 2 is programmed to begin..

HOLD MODE - M037*

Hold Mode is used to disable the pumps during service functions like cleaning or replacing the filter. Hold Mode will last for 1 hour unless the mode is exited manually. If spa service will require more than an hour, it may be best to simply shut down power to the spa.

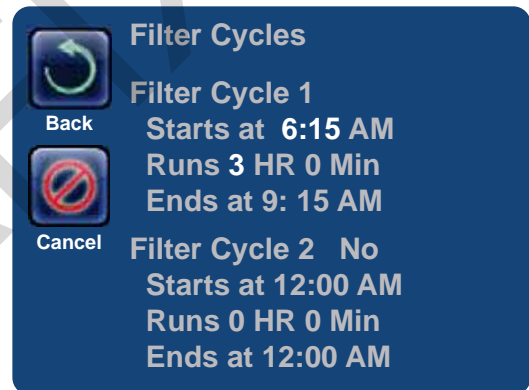
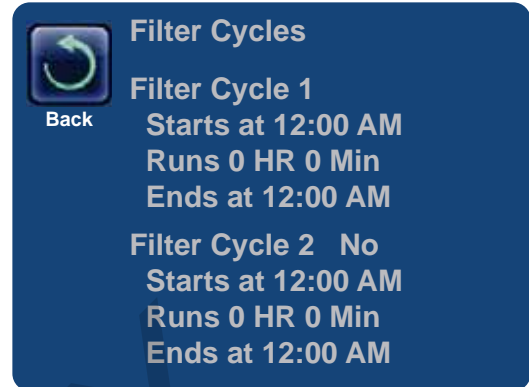

TP800, TP900 Panel Lock & Unlock

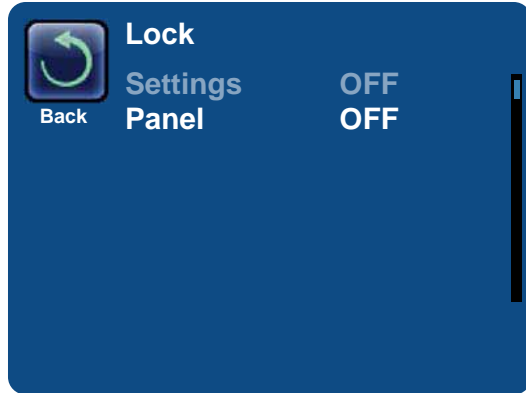

RESTRICTING OPERATION (LOCKING THE PANEL)

Main Screen > Settings > Lock

- The control can be restricted to prevent unwanted use or temperature adjustments.
- Locking the Panel prevents the controller from being used, but all automatic functions are still active.
- Locking the Settings allows Jets and other features to be used, but the Set Temperature and other programmed settings cannot be adjusted.
- Settings Lock allows access to a reduced selection of menu items. These include Set Temperature, Invert, Lock, Utilities, Information and Fault Log. They can be seen, but not changed or edited.

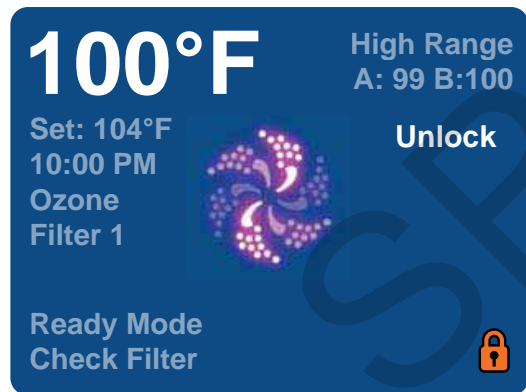

UNLOCKING THE PANEL

Main Screen > Unlock > [Right] > [Select] > [Select] > [Down]

- Unlocking the panel is accomplished from within the Lock Screen. The Unlock Sequence is the same for both Panel Lock and Settings Lock. However, the Panel must be unlocked before the Settings is unlocked.
- **NOTE:** When inside the Lock Screen, be sure that "Settings" or "Panel" is highlighted and not "Back" before using the key sequence below.

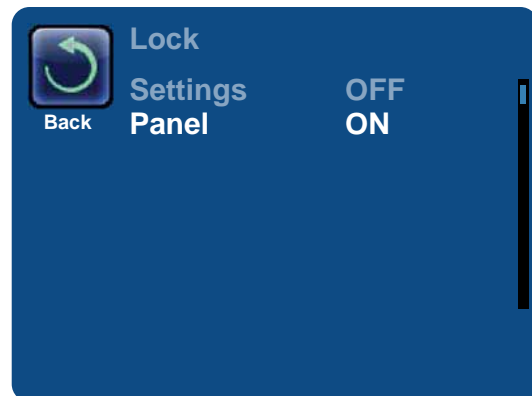

TP800, TP900 Sensor and System Related Messages

SYSTEM INFORMATION

The System Information Menu displays various settings and identification of the particular system. As each item in the menu is highlighted, the detail for that item is displayed at the bottom of the screen.

SOFTWARE ID: (SSID)

Displays the software ID number for the System.

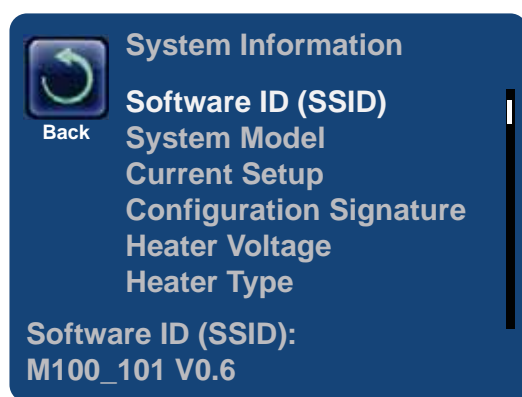

SYSTEM MODEL

Displays the Model Number of the System.

CURRENT SETUP

Displays the currently selected Configuration Setup Number.

CONFIGURATION SIGNATURE

Displays the checksum for the system configuration file.

HEATER VOLTAGE (FEATURE NOT USED ON CE RATED SYSTEMS.)

Displays the operating voltage configured for the heater.

HEATER WATTAGE AS CONFIGURED IN SOFTWARE (CE SYSTEMS ONLY)

Displays a heater kilowatt rating as programmed into the control system software (1-3 or 3-6).

HEATER TYPE

Displays a heater type ID number.

DIP SWITCH SETTINGS

Displays a number that represents the DIP switch positions of S1 on the main circuit board.

PANEL VERSION

Displays a number of the software in the topside control panel.

HEATER RELATED MESSAGES

THE WATER FLOW IS LOW – M016

There may not be enough water flow through the heater to carry the heat away from the heating element. Heater start up will begin again after about 1 min. See "Flow Related Checks" below.

THE WATER FLOW HAS FAILED* – M017

There is not enough water flow through the heater to carry the heat away from the heating element and the heater has been disabled. See "Flow Related Checks" below. After the problem has been resolved, you must press any button to reset and begin heater start up.

THE HEATER MAY BE DRY* – M028

Possible dry heater, or not enough water in the heater to start it. The spa is shut down for 15 min. Press any button to reset the heater start-up. See "Flow Related Checks" below.

THE HEATER IS DRY* – M027

There is not enough water in the heater to start it. The spa is shut down. After the problem has been resolved, you must clear the message to restart heater start up. See "Flow Related Checks" below.

THE HEATER IS TOO HOT* – M030

One of the water temp sensors has detected 118°F (47.8°C) in the heater and the spa is shut down. You must clear the message when water is below 108°F (42.2°C). See "Flow Related Checks" below.

FLOW-RELATED CHECKS

Check for low water level, suction flow restrictions, closed valves, trapped air, too many closed jets and pump prime.

Note: On some systems, even when spa is shut down by an error condition, some equipment may occasionally turn on to * or if freeze protection is needed.

TP800, TP900 Sensor and System Related Messages (cont.)

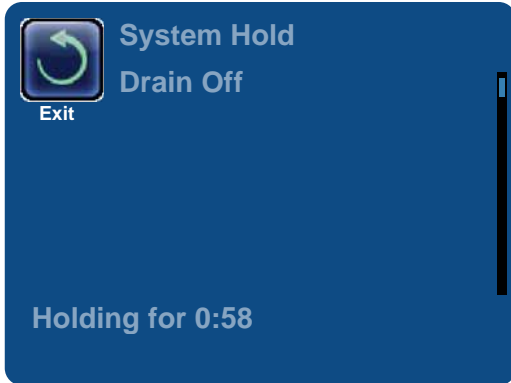

DRAIN MODE

[Main Screen > Settings > Hold > Drain](#)

Some spas have a special feature that allows Pump 1 to be employed when draining the water.

When available, this feature is a component of Hold mode.

UTILITIES MENU

[Main Screen > Settings > Utilities](#)

The Utilities Menu contains the following:

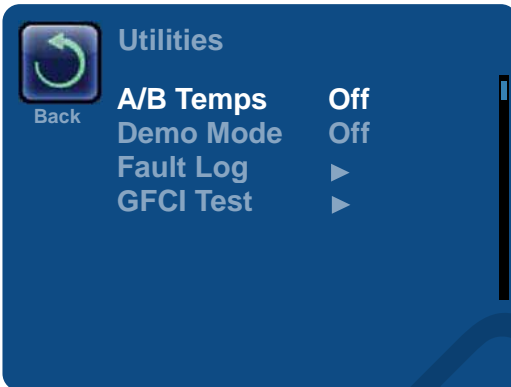

A/B TEMPS

When this is set to On, the temperature display will alternate to display temperature from Sensor A and Sensor B in the heater.

DEMO MODE

[Main Screen > Settings > Utilities > Demo Mode](#)

Demo mode is not always enabled, so it may not appear. This is designed to operate several devices in a sequence in order to demonstrate the various features of a particular hot tub.

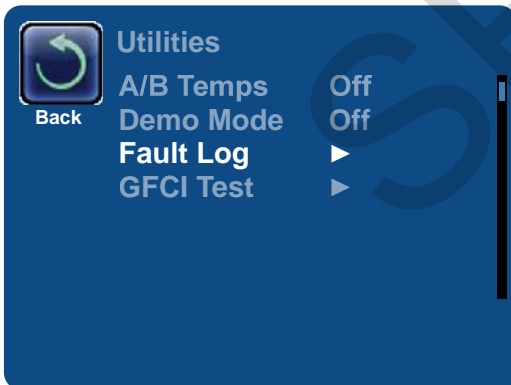

FAULT LOG: TP800, TP900

[Main Screen > Settings > Utilities > Fault Log](#)

The Fault Log is a record of the last 24 faults that can be reviewed by a service tech.

GFCI TEST (FEATURE NOT AVAILABLE ON CE RATED SYSTEMS.)

GFCI Test is not always enabled, so it may not appear. This screen allows the GFCI to be tested manually from the panel and can be used to reset the automatic test feature. If the GFCI Test Feature is reset, the device will trip within 7 days.

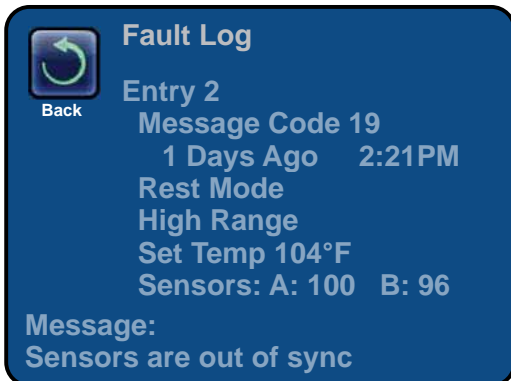

TP800, TP900 Sensor and System Related Messages (cont.)

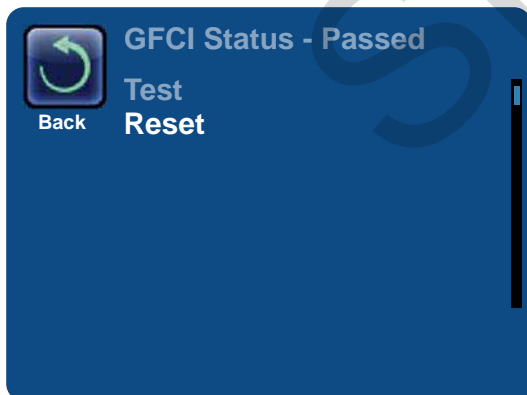
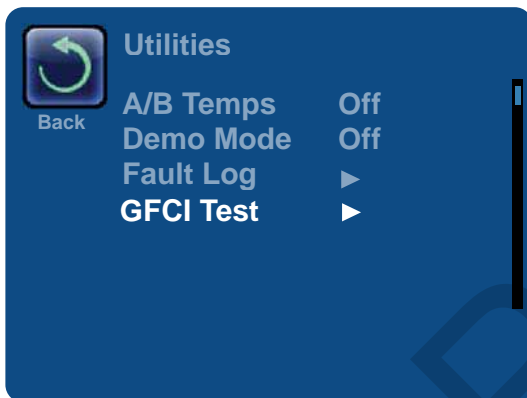
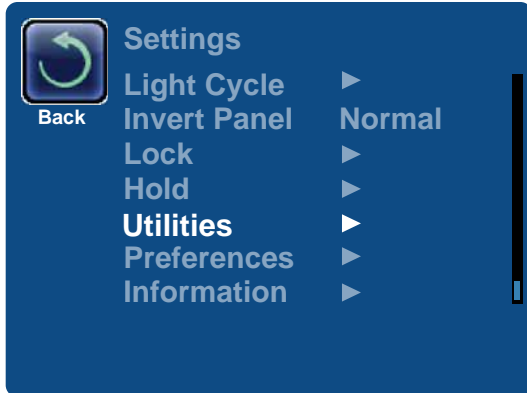

THE GROUND FAULT CIRCUIT INTERRUPTER (GFCI)

The Ground Fault Circuit Interrupter (GFCI) or Residual Current Detector (RCD) is an important safety device and is required equipment on a hot tub installation. ***(The GFCI Test Feature is not available on CE rated systems.)***

USED FOR VERIFYING A PROPER INSTALLATION

Your spa may be equipped with a GFCI Protection feature. If your spa has this feature enabled by the manufacturer, the GFCI Trip Test must occur to allow proper spa function.

Within 1 to 7 days after startup, the spa will trip the GFCI to test it. (The number of days is factory programmed.) The GFCI must be reset once it has tripped. After passing the GFCI Trip Test, any subsequent GFCI trips will indicate a ground fault or other unsafe condition and the power to the spa must be shut off until a service person can correct the problem.

FORCING THE GFCI TRIP TEST

The installer can cause the GFCI Trip Test to occur sooner by initiating it using the above menu.

The GFCI should trip within several seconds and the spa should shut down. If it does not, shut down the power and have a qualified person verify that the GFCI breaker is installed and that the circuit and spa are wired correctly. Verify the function of the GFCI with its own test button. Restore power to the spa and repeat the GFCI Trip Test.

Once the GFCI is tripped by the test, reset the GFCI and the spa will operate normally from that point. You can verify a successful test by navigating to the above menu. PASS should appear after a temp button is pressed from the GFCI Screen.

WARNING:

- The end-user must be told to expect this one-time test to occur and how to properly reset the GFCI.
- If freezing conditions exist, the GFCI should be reset immediately or spa damage could result.

CE PRODUCT:

- CE registered systems do not have an RCD Test Feature due to the nature of the electrical service.
- Some UL registered systems do not have the GFCI Test Feature activated.
- The end-user must be trained how to properly test and reset the RCD.

TP800, TP900 Sensor and System Related Messages (cont.)

MOST MESSAGES AND ALERTS WILL APPEAR AT THE BOTTOM OF THE NORMALLY USED SCREENS.

Several alerts and messages may be displayed in a sequence. Some messages can be reset from the panel. Messages that can be reset will appear with a “right arrow” at the end of the message. This message can be selected by navigating to it at pressing the Select button.



Clean the filter ►

WATER TEMPERATURE IS UNKNOWN

---°F ---°C

After the pump has been running for 1 minute, the temperature will be displayed.

POSSIBLE FREEZING CONDITION

A potential freeze condition has been detected, or the Aux Freeze Switch has closed. All water devices are activated.

In some cases, pumps may turn on and off and the heater may operate during Freeze Protection. This is an operational message, not an error indication.

THE WATER IS TOO HOT – M029

The system has detected a spa water temp of 110°F (43.3°C) or more, and spa functions are disabled. System will auto reset when the spa water temp is below 108°F (42.2°C). Check for extended pump operation or high ambient temp.

SENSORS ARE OUT OF SYNC – M015

The temperature sensors MAY be out of sync by 2°F or 3°F.

SENSORS ARE OUT OF SYNC -- CALL FOR SERVICE* – M026

The temperature sensors ARE out of sync. The fault above has been established for at least 1 hour.

SENSOR A FAULT, SENSOR B FAULT – SENSOR A: M031, SENSOR B: M032

A temperature sensor or sensor circuit has failed. Call for Service

COMMUNICATIONS ERROR

The control panel is not receiving communication from the System.

TEST SOFTWARE INSTALLED

The Control System is operating with test software.

°F OR °C IS REPLACED BY °T

The Control System is in Test Mode.

PROGRAM MEMORY FAILURE* – M022

At Power-Up, the system has failed the Program Checksum Test. This indicates a problem with the firmware (operation program) and requires a service call.

THE SETTINGS HAVE BEEN RESET (PERSISTENT MEMORY ERROR)* – M021

Contact your dealer or service organization if this message appears on more than one power-up.

THE CLOCK HAS FAILED* – M020

CONFIGURATION ERROR - SPA WILL NOT START UP

THE GFCI TEST FAILED (SYSTEM COULD NOT TEST THE GFCI) – M036

(North America Only) May indicate an unsafe installation.

A PUMP MAY BE STUCK ON – M034

Water may be overheated. **POWER DOWN THE SPA. DO NOT ENTER THE WATER.**

HOT FAULT – M035

A Pump Appears to have been Stuck ON when spa was last powered. **POWER DOWN THE SPA. DO NOT ENTER THE WATER.**

TP800, TP900 Utilities Menu

THE UTILITIES MENU CONTAINS THE FOLLOWING:

PREFERENCES

The Preferences Menu allows the user to change certain parameters based on personal preference.

TEMP DISPLAY

Change the temperature between Fahrenheit and Celsius.

TIME DISPLAY

Change the clock between 12 hr and 24 hr display.

REMINDERS

Turn the reminder messages (like "Clean Filter") On or Off.

CLEANUP

Cleanup Cycle Duration is not always enabled, so it may not appear. When it is available, set the length of time Pump 1 will run after each use. 0-4 hours are available.

DOLPHIN II AND DOLPHIN III (APPLIES TO RF DOLPHIN ONLY)

When set to 0, no addressing is used. Use this setting for a Dolphin II or Dolphin III which is factory set for no address by default. When set between 1 and 7, the number is the address. (See *Optional Balboa Dolphin Remote* within this manual, or the Dolphin III domestic manual for details, Doc. No. 50211.)

COLOR OF BACKGROUND

Pressing the Select Button when Color is highlighted will cycle through 5 background colors available in the control.

LANGUAGE

Change the language displayed on the panel.

TP400, TP600 Standard Panel Operations - Main Screen - Navigation

Note: TP400 menu structure is similar to the TP600. This section is only for quick reference as it applies to troubleshooting. For complete menu operations, please refer to BVG user guide, document No. 40940 or user guide 42185 for simplified menus. TP400/TP600 error codes and fault messages are similar to TP800/TP900.

Navigation

Navigating the entire menu structure is done with 2 or 3 buttons on the control panel.



Some panels have separate **WARM** (Up) and **COOL** (Down) buttons, while others have a single **Temperature** button. In the navigation diagrams Temperature buttons are indicated by a single button icon.

Panels that have two Temperature buttons (Warm and Cool) can use both of them to simplify navigation and programming where a single Temperature icon is shown.

The **LIGHT** Button is also used to choose the various menus and navigate each section.

Typical use of the Temperature button(s) allows changing the Set Temperature while the numbers are flashing in the LCD.

Pressing the **LIGHT** button while the numbers are flashing will enter the menus.

The menus can be exited with certain button presses. Simply waiting for several seconds will return the panel operation to normal.

Power-up Screens

Each time the System powers up, a series of numbers is displayed. After the startup sequence of numbers, the system will enter Priming Mode (See Page 3).

Key

- Indicates Flashing or Changing Segment
- Indicates Alternating or Progressive Message - every 1/2 second
- ⬇ A temperature button, used for "Action"
- ☼ Light or dedicated "Choose" button, depending on control panel configuration
- Waiting time that keeps the last change to a menu item.
- ***** Waiting time (depends on menu item) that reverts to original setting and ignores any change to that menu item.

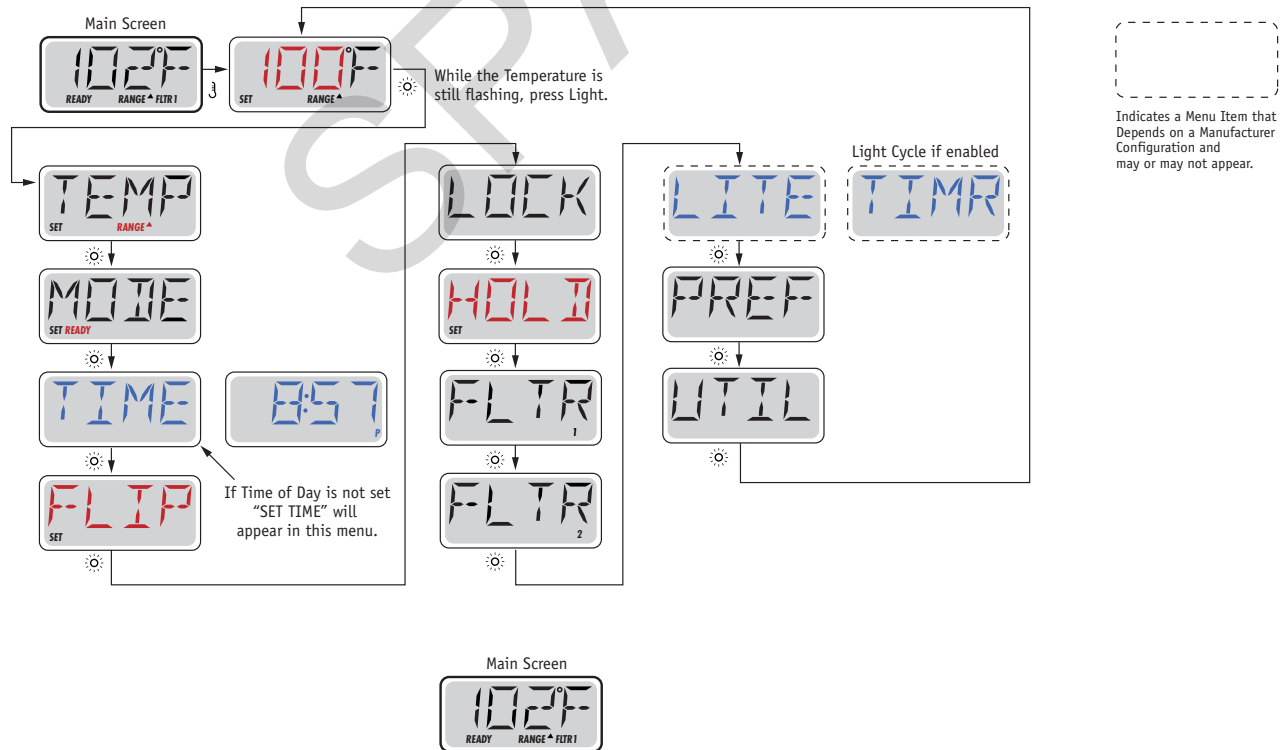

Waiting Several Seconds in the Main Menu will allow the display to revert to the Main Screen. Most changes are not saved unless Light ☼ is pressed. Refer to Key above.

TP400, TP600 Panel Utilities Menu

If the system can power up, you have access to the Utilities and Fault Log menus.

Key

- Indicates Flashing or Changing Segment
- Indicates Alternating or Progressive Message - every 1/2 second
- A temperature button, used for "Action"
- Light or dedicated "Choose" button, depending on control panel configuration
- Waiting time that keeps the last change to a menu item.
- ***** Waiting time (depends on menu item) that reverts to original setting and ignores any change to that menu item.

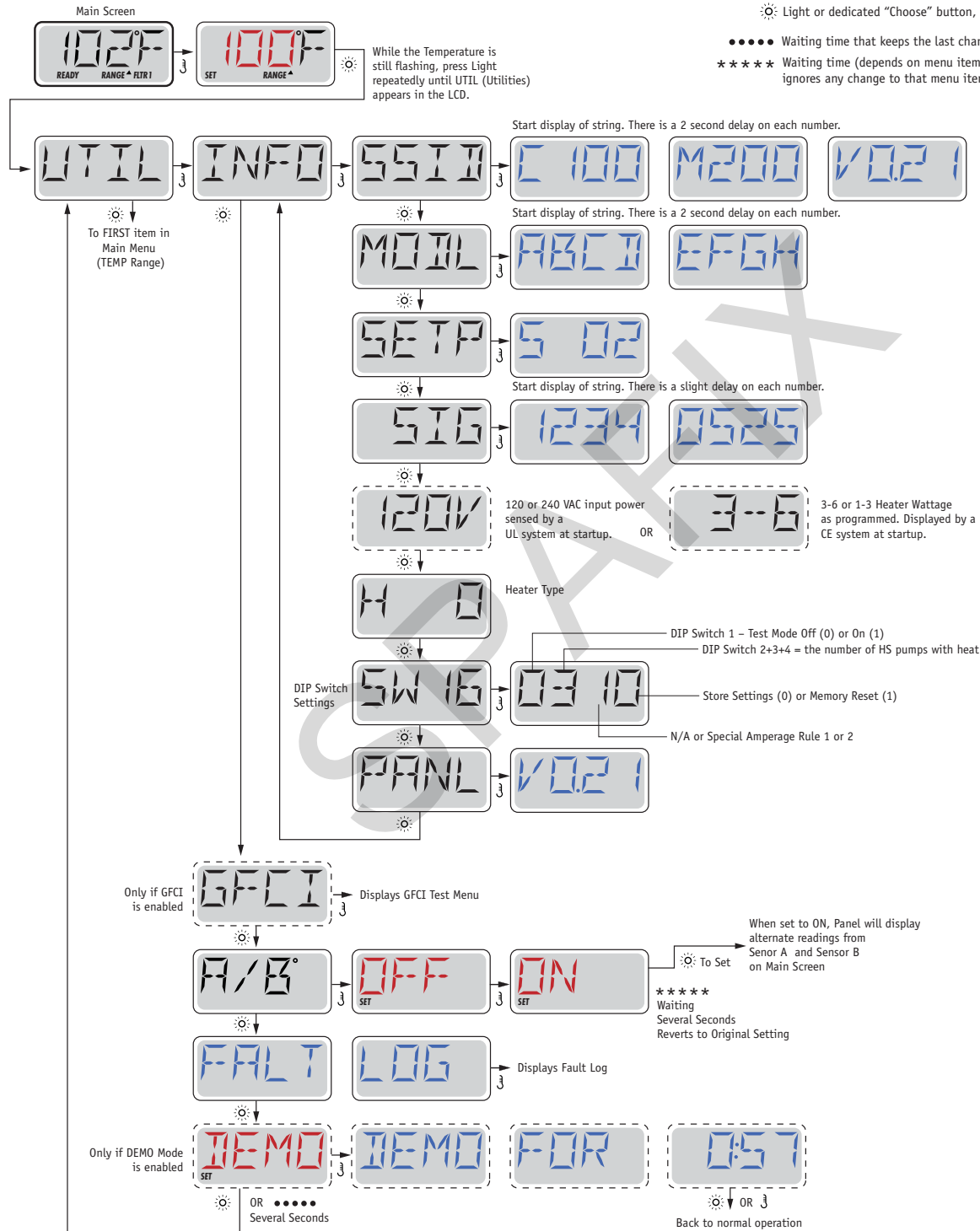

TP400, TP600 Preparation and Priming

PREPARATION AND FILLING

Fill the spa to its correct operating level. Be sure to open all valves and jets in the plumbing system before filling to allow as much air as possible to escape from the plumbing and the control system during the filling process.

After turning the power on at the main power panel, the top-side panel display will go through specific sequences. These sequences are normal and display a variety of information regarding the configuration of the hot tub control.

PRIMING MODE – M019*



This mode will last for 4-5 minutes or you can manually exit the priming mode after the pump(s) have primed. Regardless of whether the priming mode ends automatically or you manually exit the priming mode, the system will automatically return to normal heating and filtering at the end of the priming mode. During the priming mode, the heater is disabled to allow the priming process to be completed without the possibility of energizing the heater under low-flow or no-flow conditions. Nothing comes on automatically, but the pump(s) can be energized by pushing the "Jet" buttons. If the spa has a Circ Pump, it can be activated by pressing the "Light" button during Priming Mode.

PRIMING THE PUMPS

As soon as the above display appears on the panel, push the "Jet" button once to start Pump 1 in low-speed and then again to switch to high-speed. Also, push the Pump 2 or "Aux" button, if you have a 2nd pump, to turn it on. The pumps will now be running in high-speed to facilitate priming. If the pumps have not primed after 2 minutes, and water is not flowing from the jets in the spa, do not allow the pumps to continue to run. Turn off the pumps and repeat the process.

Note: Turning the power off and back on again will initiate a new pump priming session. Sometimes momentarily turning the pump off and on will help it to prime. Do not do this more than 5 times. If the pump(s) will not prime, shut off the power to the spa.

Important: A pump should not be allowed to run without priming for more than 2 minutes. Under NO circumstances should a pump be allowed to run without priming beyond the end of the 4-5 minute priming mode. Doing so may cause damage to the pump and cause the system to energize the heater and go into an overheat condition.

EXITING PRIMING MODE

You can manually exit Priming Mode by pressing a "Temp" button (Up or Down). Note that if you do not manually exit the priming mode as described above, the priming mode will be automatically terminated after 4-5 minutes. Be sure that the pump(s) have been primed by this time.

Once the system has exited Priming Mode, the top-side panel will momentarily display the set temperature but the display will not show the temperature yet, as shown below. This is because the system requires approximately 1 minute of water flowing through the heater to determine the water temperature and display it.

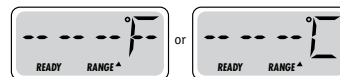

TP400, TP600 Message Codes

The following are messages and features that can appear on the TP400 and TP600 panels.

NOTE: LCD readouts may look slightly different than shown on screen.

MESSAGE CODES

(Found on the pages listed)

M0[XX] numbers are Message Codes 46

M015 53, 60

M016 50, 59

M017 50, 59

M019 59

M019* 46

M020 53, 60

M021 53, 60

M022 53, 60

M026 53, 60

M027 50

M028 50, 59

M029 53, 59

M030 50, 59

M031 60

M031, Sensor A: 53

M032 60

M032, Sensor B: 53

M033 59

M034 53, 60

M035 53, 60

M036 53, 60

M037* 48

DEMO (DEMO MODE)

Demo Mode is not always enabled, so it may not appear. This is designed to operate several devices in a sequence in order to demonstrate the various features of a particular hot tub.

INFO (SYSTEM INFORMATION SUB-MENU)

The System Information Menu displays various settings and identification of the particular system. As each item in the menu is highlighted, the detail for that item is displayed at the bottom of the screen.

SSID (SOFTWARE ID)

Displays the software ID number for the System.

MODL (SYSTEM MODEL)

Displays the Model Number of the System.

SETP (CURRENT SETUP)

Displays the currently selected Configuration Setup Number.

SIG (CONFIGURATION SIGNATURE)

Displays the checksum for the system configuration file.

HEATER VOLTAGE (FEATURE NOT USED ON CE RATED SYSTEMS)

Displays the operating voltage configured for the heater.

HEATER WATTAGE AS CONFIGURED IN SOFTWARE (CE SYSTEMS ONLY)

Displays a heater kilowatt rating as programmed into the control system software (1-3 or 3-6).

H _ (HEATER TYPE)

Displays a heater type ID number.

SW _ (DIP SWITCH SETTINGS)

Displays a number that represents the DIP switch positions of S1 on the main circuit board.

PANL (PANEL VERSION)

Displays a number of the software in the topside control panel.

A / B (A/B SENSOR TEMPERATURES)

When this is set to On, the temperature display will alternate to display temperature from Sensor A and Sensor B in the heater.

TP400, TP600 Messages (cont.)

FALT LOG (FAULT LOG)

The Fault Log is a record of the last 24 faults that can be reviewed by a service tech.

SCROLLING TP400/TP600 MESSAGES

The following messages will scroll across the TP400/TP600 panels. **NOTE:** LCD readouts may look slightly different than shown on screen.

RUN PMPS PURG AIR ----

PRIMING MODE – M019

Each time the spa is powered up, it will enter Priming Mode. The purpose of Priming Mode is to allow the user to run each pump and manually verify that the pumps are primed (air is purged) and water is flowing. This typically requires observing the output of each pump separately, and is generally not possible in normal operation. Priming Mode lasts 4 minutes, but you can exit it earlier by pressing any Temp button. The heater is not allowed to run during Priming Mode.

NOTE: If your spa has a Circ Pump, it will turn on with Jets 1 in Priming Mode. The Circ Pump will run by itself when Priming Mode is exited.

-- -- °F -- -- °C

Water Temperature is Unknown

After the pump has been running for 1 minute, the temperature will be displayed.

42 °F TOO COLD

Too Cold - Freeze Protection

A potential freeze condition has been detected, or the Aux Freeze Switch has closed, and all pumps and blower are activated. All pumps and blower are ON for at least 4 minutes after the potential freeze condition has ended, or when the aux freeze switch opens. In some cases, pumps may turn on and off and the heater may operate during Freeze Protection. This is an operational message, not an error indication.

WATR TOO HOT -- -- --

Water is too Hot (OHS) – M029

One of the water temp sensors has detected spa water temp 110°F (43.3°C) and spa functions are disabled. System will auto reset when the spa water temp is below 108°F (42.2°C). Check

for extended pump operation or high ambient temp.

SFTY TRIP -- -- --

Safety Trip - Pump Suction Blockage* – M033

The Safety Trip error message indicates that the vacuum switch has closed. This occurs when there has been a suction problem or a possible entrapment situation avoided. (Note: not all spas have this feature.)

HTR FLOW LOSS -- -- --

Heater Flow is Reduced (HFL) – M016

There may not be enough water flow through the heater to carry the heat away from the heating element. Heater start up will begin again after about 1 min. See "Flow Related Checks" below.

HTR FLOW FAIL -- -- --

Heater Flow is Reduced (LF)* – M017

There is not enough water flow through the heater to carry the heat away from the heating element and the heater has been disabled. See "Flow Related Checks" below. After the problem has been resolved, you must press any button to reset and begin heater start up.

HTR MAY BE DRY -- -- -- WAIT -- -- --

Heater May be Dry (dr)* – M028

Possible dry heater, or not enough water in the heater to start it. The spa is shut down for 15 min. Press any button to reset the heater start-up. See "Flow Related Checks" below.

HTR TOO HOT -- -- --

HTR is too Hot (OHH)* M030

One of the water temp sensors has detected 118°F (47.8°C) in the heater and the spa is shut down. You must press any button to reset when water is below 108°F (42.2°C). See "Flow Related Checks" below.

PRES BTTN TO RSET -- -- --

A Reset Message May Appear with other Messages.

Some errors may require power to be removed and restored.

TP400, TP600 Messages (cont.)

FLOW-RELATED CHECKS

Check for low water level, suction flow restrictions, closed valves, trapped air, too many closed jets and pump prime. On some systems even when spa is shut down, some equipment may occasionally turn on to continue monitoring temperature or if freeze protection is needed.

102°F SNSR BAL-- ANCE

Sensor Balance is Poor – M015

The temperature sensors MAY be out of sync by 2°F or 3°F.

SNSR SYNC -- -- -- -- CALL FOR SRVC -- -- -- --

Sensor Balance is Poor* – M026

The temperature sensors ARE out of sync. The Sensor Balance is Poor fault has been established for at least 1 hour.

SNSR A -- -- -- -- CALL FOR SRVC -- -- -- --

SNSR B -- -- -- -- CALL FOR SRVC -- -- -- --

Sensor Failure – Sensor A: M031, Sensor B: M032

A temperature sensor or sensor circuit has failed.

NO COMM

No Communications

The control panel is not receiving communication from the System.

BETA VER-- SION -- -- -- --

Pre-Production Software

The Control System is operating with test software.

102 °T

°F or °C is replaced by °T

The Control System is in Test Mode.

MEM FAIL -- -- -- --

Memory Failure - Checksum Error* – M022

At Power-Up, the system has failed the Program Checksum Test. This indicates a problem with the firmware (operation program) and requires a service call.

MEM RSET -- -- -- --

Memory Warning - Persistent Memory Reset* – M021

Appears after any system setup change. Contact your dealer or service organization if this message appears on more than one power-up, or if it appears after the system has been running normally for a period of time.

CLOK FAIL -- -- -- --

Memory Failure - Clock Error* – M020

Not Applicable on the BP1500.

CNFG FAIL -- -- -- --

Configuration Error - Spa will not Start Up

GFCI FAIL -- -- -- --

GFCI Failure - System Could Not Test/Trip the GFCI – M036

NORTH AMERICA ONLY. May indicate an unsafe installation.

STUK PUMP -- -- -- --

A Pump Appears to be Stuck ON – M034

Water may be overheated. POWER DOWN THE SPA. DO NOT ENTER THE WATER.

HOT FALT -- -- -- -- CALL FOR SRVC -- -- -- --

A Pump Appears to have been Stuck ON when spa was last powered – M035

POWER DOWN THE SPA. DO NOT ENTER THE WATER.

TP400, TP600 Utilities Fault Log Menu

THE FAULT LOG

The Fault Log stores up to 24 events in memory and they can be reviewed under the Fault Log Menu. The Fault Log is a record of the last 24 faults that can be reviewed by a service tech.

Each event captures a Fault Message Code, how many days have passed since the fault, Time of the fault, Set Temperature during the fault, and Sensor A and B temperatures during the fault. The Fault Log is also available from the Test Menu (in Test Mode).

- Pressing TEMP at any fault event reveals a Message Code
- Continuing to press TEMP reveals additional information for that specified numbered fault event.
- Waiting 30 seconds inside the fault log menu allows the screen to return to normal operation.

FAULT LOG MESSAGE CODES: TP400, TP600

- MXXX: Fault Message Code
- DZZZ: How many days have passed since the fault
- Time of the fault
- Set Temperature during the fault
- Sensor A Temperature during the fault
- Sensor B Temperature during the fault

Key

- Indicates Flashing or Changing Segment
- Indicates Alternating or Progressive Message - every 1/2 second
- ⌵ A temperature button, used for "Action"
- ☉ Light or dedicated "Choose" button, depending on control panel configuration
- Waiting time - varies depending on function

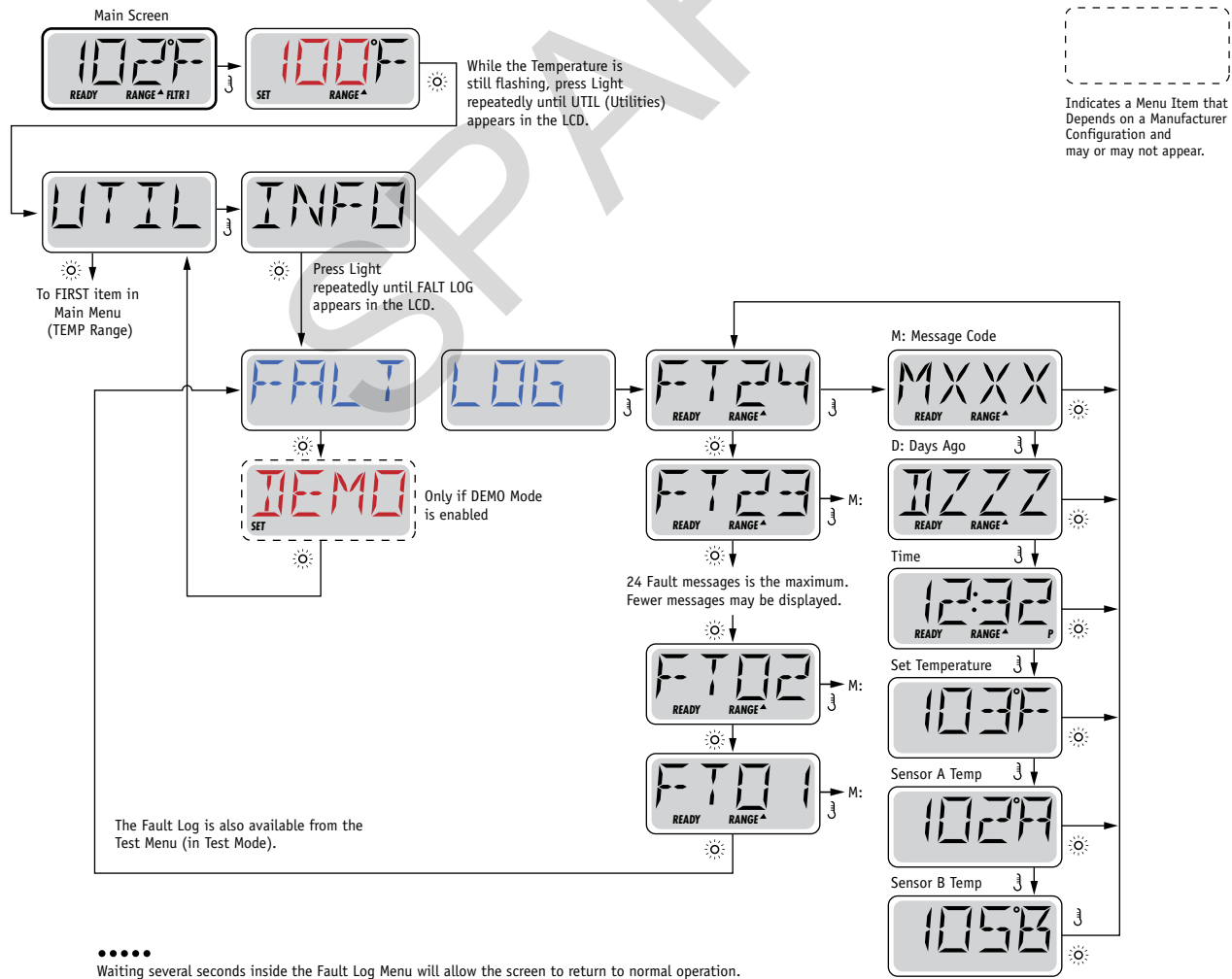

TP400, TP600 Utilities Menu - GFCI Test Feature

Not Available on CE Rated Systems.

A GFCI is an important safety device and is required equipment on a hot tub installation.

Your spa may be equipped with a GFCI Protection feature. (UL rated systems only.) If your spa has this feature enabled by the manufacturer, the GFCI Trip Test must occur to allow proper spa function.

Within 1 to 7 days after startup, the spa will trip the GFCI to test it. (The number of days is factory programmed.) The GFCI must be reset once it has tripped. After passing the GFCI Trip Test, any subsequent GFCI trips will indicate a ground fault or other unsafe condition and the power to the spa must be shut off until a service person can correct the problem.

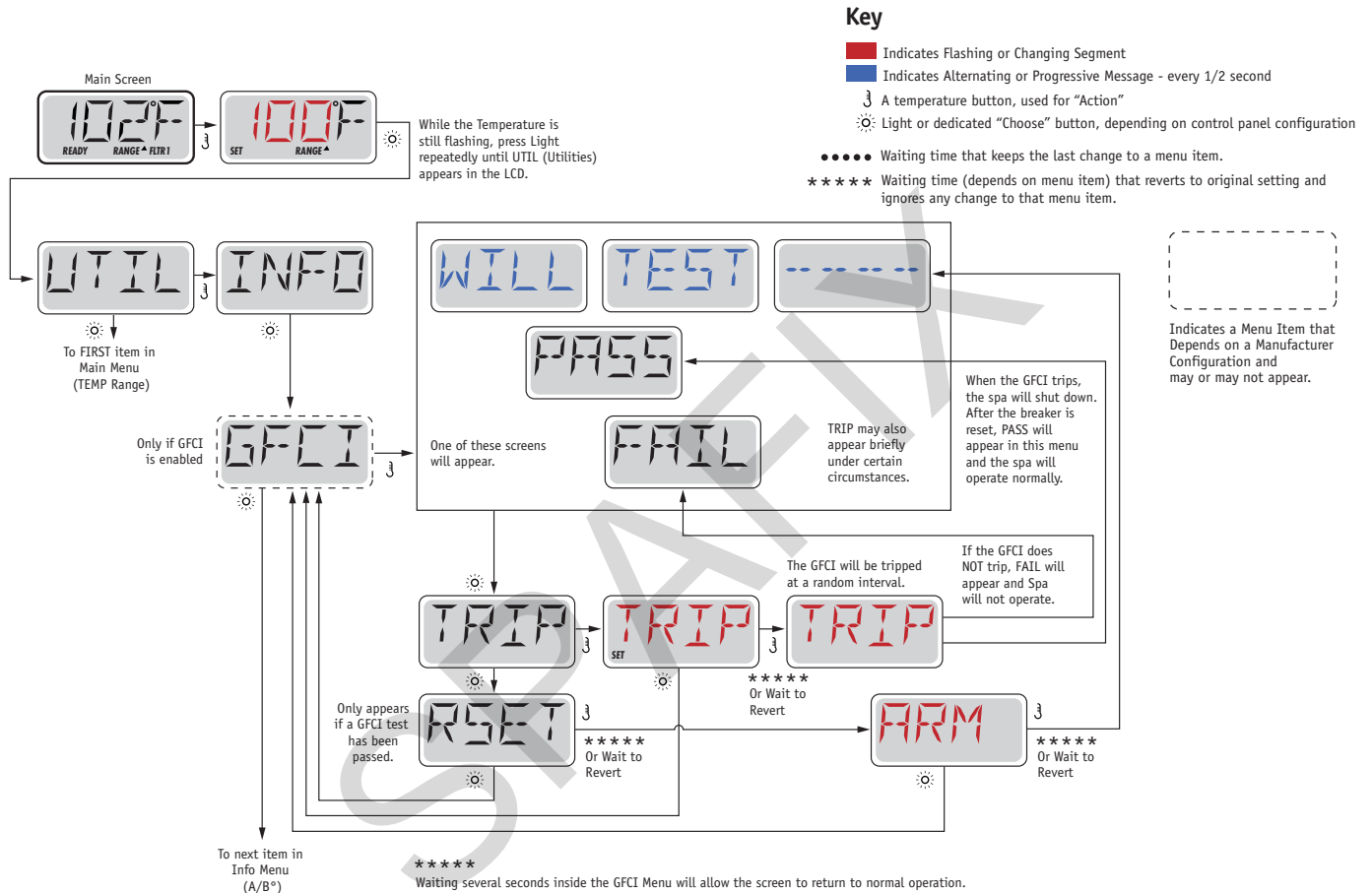

Forcing the GFCI Trip Test

The installer can cause the GFCI Trip Test to occur sooner by initiating it using the above menu.

The GFCI should trip within several seconds and the spa should shut down. If it does not, shut down the power and manually verify that a GFCI breaker is installed and that the circuit and spa are wired correctly. Verify the function of the GFCI with its own test button. Restore power to the spa and repeat the GFCI Trip Test.

Once the GFCI is tripped by the test, reset the GFCI and the spa will operate normally from that point. You can verify a successful test by navigating to the above menu. PASS should appear after a temp button is pressed from the GFCI screen.

The end-user must be trained to expect this one-time test to occur and how to properly reset the GFCI.

Warning:

If freezing conditions exist, a GFCI should be reset immediately or spa damage could result. The end user should always trained to test and reset the GFCI on a regular basis.

TP400, TP600 Simplified vs. Standard Panel Operations

SIMPLIFIED MENUS

Simplified Menus is an option that manufacturers (OEM's) offer to their end users in order to provide an easier to navigate menu. A simplified menu structure does not have extended features such as Utilities, Restricting Operation, Unlocking, and so on; yet, provides basic spa operations that satisfy the needs of end users. Navigating the menu structure is similar for both standard and simplified menus, which is done using two or three buttons on the control panel.

All TP600 and TP400 panels are compatible with simplified menus and standard menus, and can access Test Mode. Regardless of menu structure, test modes have full functionality. The control panel user guides for standard and simplified menus are different: Balboa user guide 40940 describes standard menus; user guide 42185 describes simplified menus.

Menu attributes are embedded within the spa control system at the factory. Swapping out one panel with another will not change a simplified menu to a standard menu, and vice versa. For the system to be changed from one menu structure to another is dependent on whether that option was programmed into the system at the time of manufacturing.

CHANGING MENUS THROUGH CONFIGURATIONS

If the option of an alternate menu structure is available, then it is possible to change the simplified menu to a standard menu, and vice versa. A technician must refer to the Tech Sheet of that particular system to see what configuration (if any) is available.

For instance, if a technician plans to install or modify a Sunrise Spas BP 240V system (in this example), and that system has standard menus that he wishes to change to simplified menus, he would refer to Tech Sheet SR240BP5 (No. 56415-97, Rev. A).

Page two provides information in the System Revision History: "*240V-only version with both Simplified Menus and Full Menus*". The next giveaway of dual menu options is the section headers on the following pages. See below.

- Page 3: An option is given to use Setup 1, or Setup 7.
- Below that, an option is given to use Setup 2, or Setup 8.
- Page 4: An option is given to use Setup 3, or Setup 9.

In these three examples (out of six possible dual menu options available for this system), Setup 1, 2, or 3 could be chosen for a simplified menu. Of course, the option is open to configure a counterpart control system to standard (full) menus by choosing Setup 7, 8, or 9 respectively.

Headings of Setups 1, 2, & 3 in Tech Sheet SR240BP5 (12-05-12, Rv. A)

Page 3: **Setup 1 – Simplified Menu (with Flip) Setup 7 – Full Menu**

Page 3: **Setup 2 – Simplified Menu (with Flip) Setup 8 – Full Menu**

Page 4: **Setup 3 – Simplified Menu (with Flip) Setup 9 – Full Menu**

TP400, TP600 Simplified and Standard Panel Main Menus

A SIMPLIFIED MAIN MENU (DOC NO. 42185B)

Main Menu

Navigation

Navigating the entire menu structure is done with 2 or 3 buttons on the control panel.



Some panels have separate **WARM** (Up) and **COOL** (Down) buttons, while others have a single **Temperature** button. In the navigation diagrams Temperature buttons are indicated by a single button icon. Panels that have two Temperature buttons (Warm and Cool) can use both of them to simplify navigation and programming where a single Temperature icon is shown.

The **LIGHT** Button is also used to choose the various menus and navigate each section.

Typical use of the Temperature button(s) allows changing the Set Temperature while the numbers are flashing in the LCD. Pressing the **LIGHT** button while the numbers are flashing will enter the menus.

The menus can be exited with certain button presses. Simply waiting for several seconds will return the panel operation to normal.

Power-up Screens

Each time the System powers up, a series of numbers is displayed. After the startup sequence of numbers, the system will enter Priming Mode (See Page 3).

Key

- Indicates Flashing or Changing Segment
- Indicates Alternating or Progressive Message - every 1/2 second
- ⌋ A temperature button, used for "Action"
- ☉ Light or dedicated "Choose" button, depending on control panel configuration
- Waiting time that keeps the last change to a menu item.
- ***** Waiting time (depends on menu item) that reverts to original setting and ignores any change to that menu item.

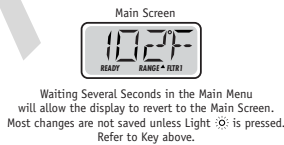
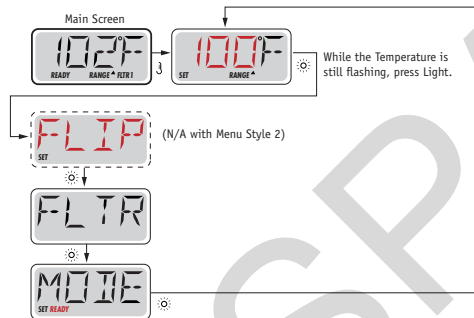

A STANDARD MAIN MENU (DOC NO. 40940I)

Both panels can be navigated using 2 or 3 buttons.

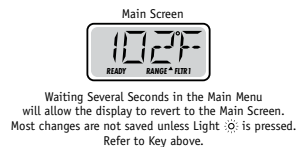
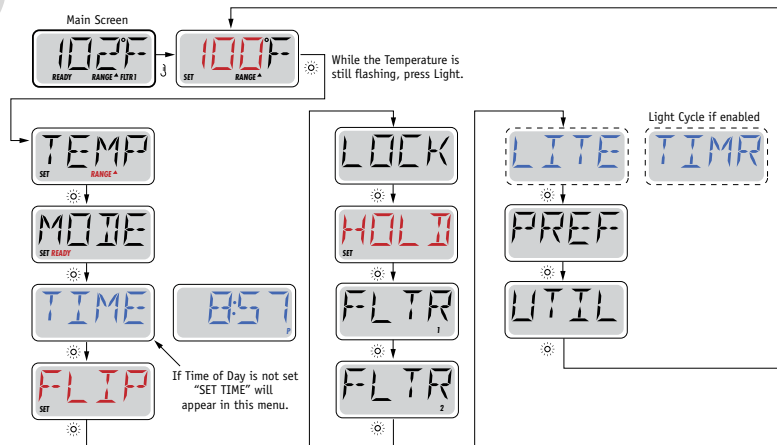

Balboa Water Group BP Wiring Diagrams

Wiring Diagram - BP2100G1, Part Number 56389-01



BP2100G1 – PN 56389-01
01-30-13

J43 TO J13 (BLOWER ON J14)
IN SETUPS 3, 5, 9, 11, 12, 17, 18

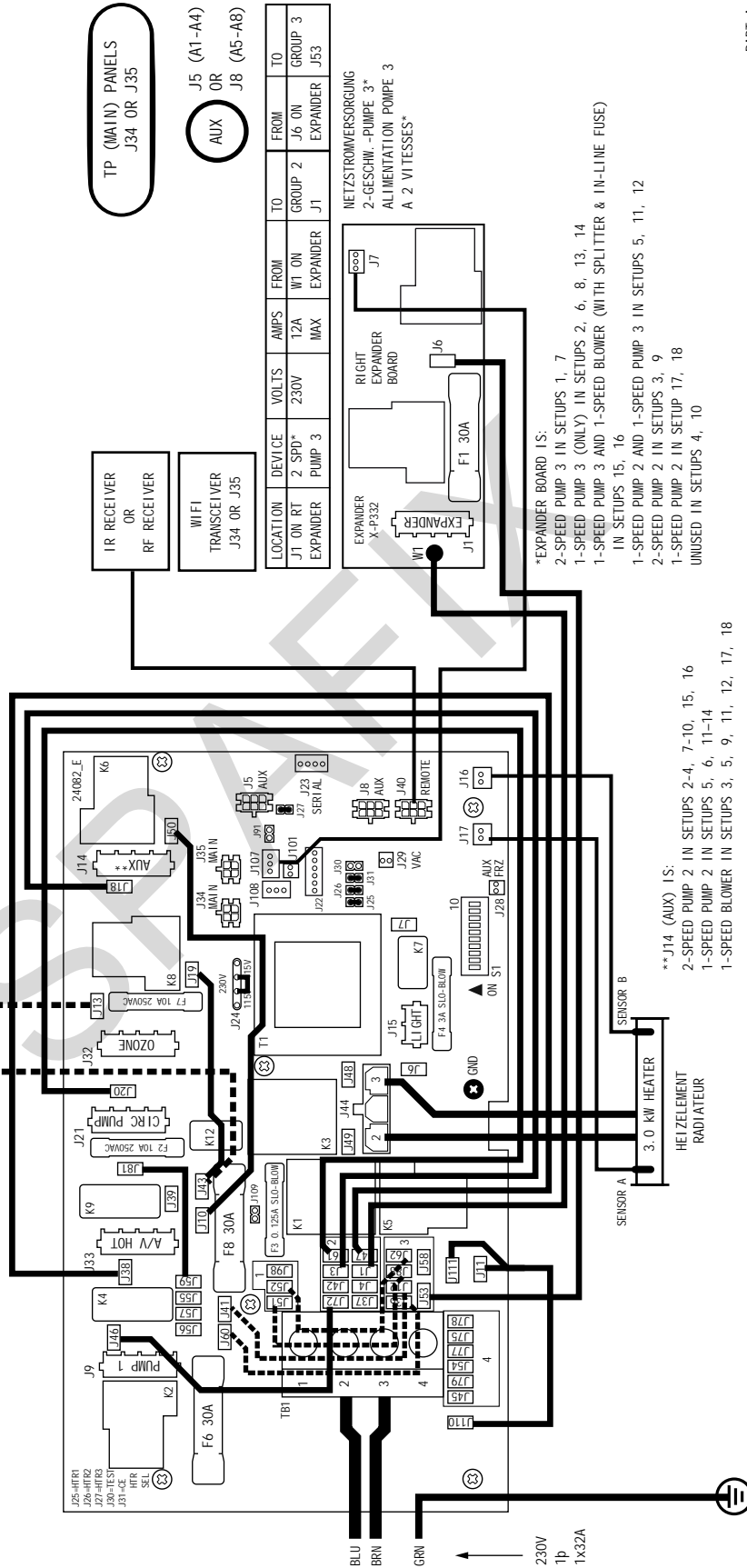

PART A

Wiring Diagram - BP2100G1, Part Number 56389-01 (cont.)

SINGLE SERVICE 230V 1p / 1x32A, THREE-SERVICE 230V 1p / 3x16A

LOCATION	DEVICE
J9	NETZSTROMVERSORGUNG 2-GE SCHW.-PUMPE 1 ALIMENTATION POMPE 1 A 2 VITESSES 2-SPEED PUMP 1
J14	AUX **
J15	AUX LINE 1 CONNECTION J19 to J43
J21	10V BELLEUCHTUNG ECLAIRAGE BAIN HYDRO SPA LIGHT
J32	KREISLAUF PUMPE POMPE DE CIRCULATION CIRC PUMP (SETUPS 7-14, 16)
J33	OZONGENERATOR GENERATOROZONE OZONE GENERATOR
J40	CIRC AND OZONE LINE 1 CONNECTION J81 to J59
J5, J8	TV / AV
J5, J8	IR RECEIVER
J5, J8	AUX PANEL(S) - AX10, AX20, AX30, AX40

TEST MODE OFF	SWITCHBANK S1 OFF	SWITCHBANK S1 ON	TEST MODE ON
DOWN T ADD 1 HS PUMP W/HTR	A1	▲	ADD 1 HS PUMP WITH HEAT
DOWN T ADD 2 HS PUMPS W/HTR	A2	▲	ADD 2 HS PUMPS WITH HEAT
DOWN T ADD 4 HS PUMPS W/HTR	A3	▲	ADD 4 HS PUMPS WITH HEAT
SPECIAL AMPERAGE RULE A	A4	▲	SPECIAL AMPERAGE RULE B
MEMORY RESET*	A5	▲	MEMORY RESET*
1 MIN HTR COOLDOWN (ELEC)	A6	▲	5 MIN HTR COOLDOWN (GAS)
NOT ASSIGNED	A7	▲	NOT ASSIGNED
NOT ASSIGNED	A8	▲	NOT ASSIGNED
NOT ASSIGNED	A9	▲	NOT ASSIGNED
NOT ASSIGNED	A10	▲	NOT ASSIGNED

*SWTCH # 6 SHOULD BE SET TO OFF UPON FINAL INSTALLATION.

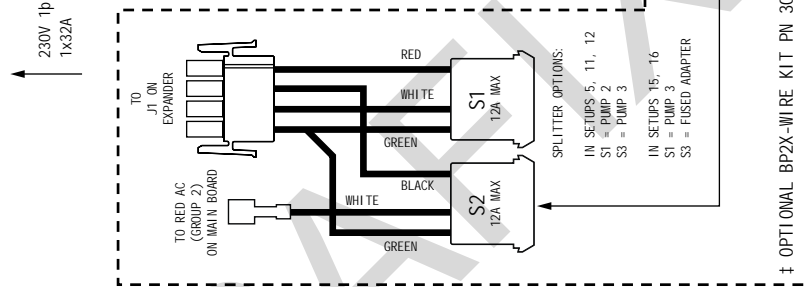

SETUP #	CIRC PUMP	PUMP 1	PUMP 2	PUMP 3	BLOWER	TEMP SCALE
1	NONE	2-SPEED	2-SPEED	2-SPEED	NONE	°C
2	NONE	2-SPEED	2-SPEED	1-SPEED	NONE	°C
3	NONE	2-SPEED	2-SPEED	NONE	1-SPEED	°C
4	NONE	2-SPEED	2-SPEED	NONE	NONE	°C
5†	NONE	2-SPEED	1-SPEED	1-SPEED	1-SPEED	°C
6	NONE	2-SPEED	1-SPEED	1-SPEED	NONE	°C
7	PROGRAMMABLE FILTRATION + POLLING	2-SPEED	2-SPEED	2-SPEED	NONE	°C
8	PROGRAMMABLE FILTRATION + POLLING	2-SPEED	2-SPEED	1-SPEED	NONE	°C
9	PROGRAMMABLE FILTRATION + POLLING	2-SPEED	2-SPEED	1-SPEED	NONE	°C
10	PROGRAMMABLE FILTRATION + POLLING	2-SPEED	2-SPEED	1-SPEED	NONE	°C
11†	PROGRAMMABLE FILTRATION + POLLING	1-SPEED	1-SPEED	1-SPEED	1-SPEED	°C
12†	PROGRAMMABLE FILTRATION + POLLING	1-SPEED	1-SPEED	1-SPEED	1-SPEED	°C
13	PROGRAMMABLE FILTRATION + POLLING	1-SPEED	2-SPEED	1-SPEED	NONE	°C
14	PROGRAMMABLE FILTRATION + POLLING	2-SPEED	2-SPEED	1-SPEED	1-SPEED	°C
15†***	NONE	2-SPEED	2-SPEED	1-SPEED	1-SPEED	°C
16†***	PROGRAMMABLE FILTRATION + POLLING	2-SPEED	2-SPEED	1-SPEED	1-SPEED	°C
17	PROGRAMMABLE FILTRATION + POLLING	1-SPEED	1-SPEED	NONE	1-SPEED	°C
18	NONE	2-SPEED	1-SPEED	NONE	1-SPEED	°C

PUMP 1 LOW TIMEOUT IS 15 MINUTES.
 †SETUPS 5, 11, 12, 15 AND 16 REQUIRE BP2X-WIRE KIT PN30893
 ***SETUPS 15 AND 16 REQUIRE ADDITIONAL FUSED ADAPTER FOR BLOWER OUTPUT THIS SYSTEM IS CONFIGURED IN SETUP #:
 INSTEAD OF SETUP #1, THIS SYSTEM IS CONFIGURED IN SETUP #:

FOR SUPPLY CONNECTIONS, USE COPPER CONDUCTORS ONLY. TORQUE RANGE FOR MAIN TERMINAL BLOCK (T81): 27-30 IN. LBS. (31.1-34.5 kg cm)
 USE CONDUCTORS SIZED ON THE BASIS OF 60°C AMPACITY BUT RATED MINIMUM OF 90°C.
 EMPLOYER UNIFORMEMENT DES CONDUCTEURS DE CUIVRE.

BP2100G1 - PN 56389-01
 01-30-13
BALBOA water group
 PART B

Wiring Diagram - BP21MSSH, Part Number: 56381



BP21MSSH – PN 56381
01-03-13

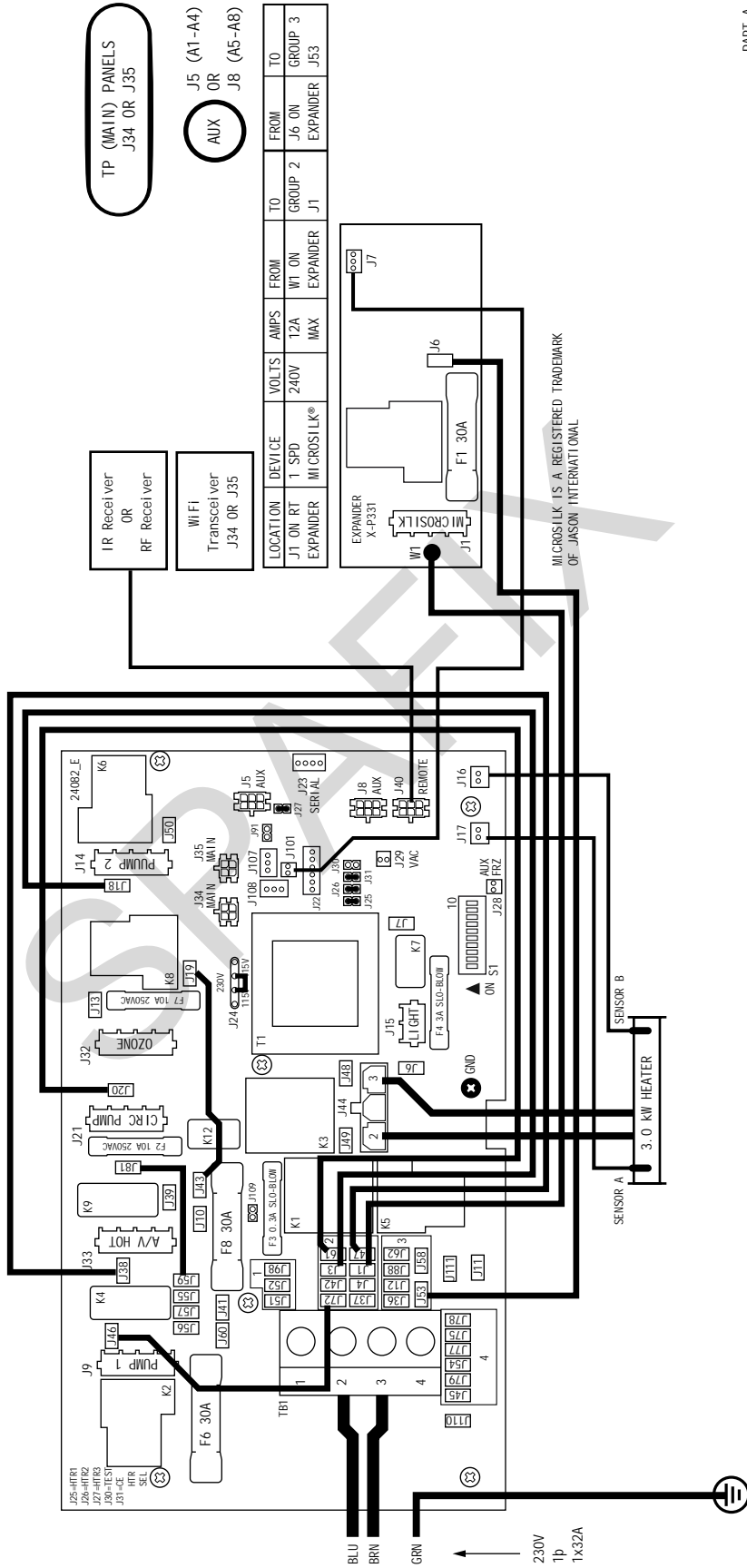

PART A

Wiring Diagram - BP21MSSH, Part Number: 56381 (cont.)

SWITCHBANK S1 OFF	SWITCHBANK S1 ON
TEST MODE OFF	TEST MODE ON
DOON'T ADD 1 HS PUMP W/HTR	ADD 1 HS PUMP WITH HEAT
DOON'T ADD 2 HS PUMPS W/HTR	ADD 2 HS PUMPS WITH HEAT
DOON'T ADD 4 HS PUMPS W/HTR	ADD 4 HS PUMPS WITH HEAT
SPECIAL AMPERAGE RULE A*	SPECIAL AMPERAGE RULE B*
STORE SETTINGS**	MEMORY RESET**
NOT ASSIGNED	NOT ASSIGNED
NOT ASSIGNED	NOT ASSIGNED
NOT ASSIGNED	NOT ASSIGNED
NOT ASSIGNED	NOT ASSIGNED

**SWITCH # 6 SHOULD BE SET TO OFF UPON FINAL INSTALLATION.

SWITCHBANK S1 OFF	SWITCHBANK S1 ON
TEST MODE OFF	TEST MODE ON
DOON'T ADD 1 HS PUMP W/HTR	ADD 1 HS PUMP WITH HEAT
DOON'T ADD 2 HS PUMPS W/HTR	ADD 2 HS PUMPS WITH HEAT
DOON'T ADD 4 HS PUMPS W/HTR	ADD 4 HS PUMPS WITH HEAT
SPECIAL AMPERAGE RULE A*	SPECIAL AMPERAGE RULE B*
STORE SETTINGS**	MEMORY RESET**
NOT ASSIGNED	NOT ASSIGNED
NOT ASSIGNED	NOT ASSIGNED
NOT ASSIGNED	NOT ASSIGNED
NOT ASSIGNED	NOT ASSIGNED

**SWITCH # 6 SHOULD BE SET TO OFF UPON FINAL INSTALLATION.

INSTEAD OF SETUP #1,
THIS SYSTEM IS CONFIGURED IN SETUP #:

SYSTEM WILL BE IN SETUP #1
UNLESS MARKED OTHERWISE

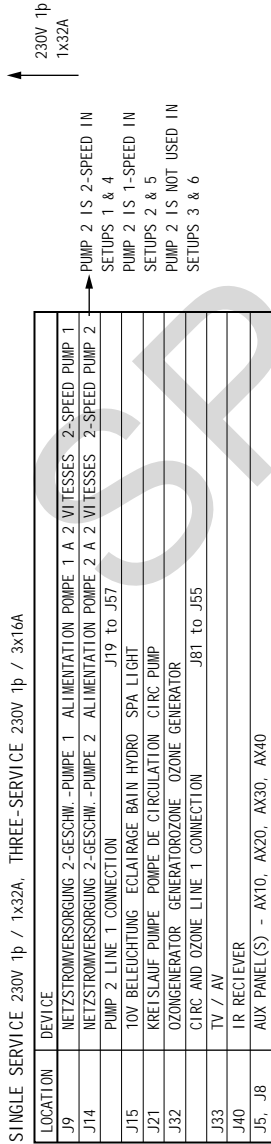

SETUP #	CIRC PUMP	PUMP 1	PUMP 2	MicroSIK®	TEMP SCALE
1	PROGRAMMABLE FILTRATION + POLLING	2-SPEED	2-SPEED	1-SPEED	°C
2	PROGRAMMABLE FILTRATION + POLLING	2-SPEED	1-SPEED	1-SPEED	°C
3	PROGRAMMABLE FILTRATION + POLLING	NONE	2-SPEED	1-SPEED	°C
4	NONE	2-SPEED	1-SPEED	1-SPEED	°C
5	NONE	2-SPEED	1-SPEED	1-SPEED	°C
6	NONE	2-SPEED	NONE	1-SPEED	°C

PUMP 1 LOW TIMEOUT IS 15 MINUTES.

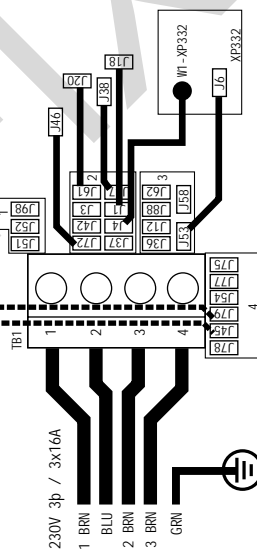

FOR SUPPLY CONNECTIONS,
USE CONDUCTORS SIZED ON THE
BASIS OF 60°C AMPACITY BUT
RATED MINIMUM OF 90°C.

USE COPPER CONDUCTORS ONLY.
EMPLOYER UNIQUÉMENT
DES CONDUCTEURS DE CUIVRE.

TORQUE RANGE FOR
MAIN TERMINAL BLOCK (TB1):
27-30 IN. LBS.
(31.1-34.5 kg cm)

BP21MSSH - PN 56381
01-03-13

PART B

Wiring Diagram - BP600/BP1600, Setup 1-16 as Manufactured

Boards Shown:

Power Board: 22117_B / 56284;

Logic Board: 22121_E / 56131-02

Power Requirements:

Single Service [3 wires (line, neutral, ground)]
 230VAC, 50Hz, 1p, 16A, (Circuit Breaker rating = 20A max.)

System Outputs - 16A Service:

Pump 1	230VAC	2-Speed	7.5A max	30-minute timer for Low Speed, 15 Minutes for High Speed
This is the heater pump Must deliver a minimum of 20 GPM through heater Low Speed may not exceed 2A max				
Pump 2	230VAC	1-Speed	7.5A max	15-minute timer
Ozone	230VAC		.5A max	Uses the same relay as Pump 1 Low
Spa Light	10VAC	On/Off	1A max	4-Hour timer.
Heater	3kW @ 240VAC			

Wiring Diagram and Settings

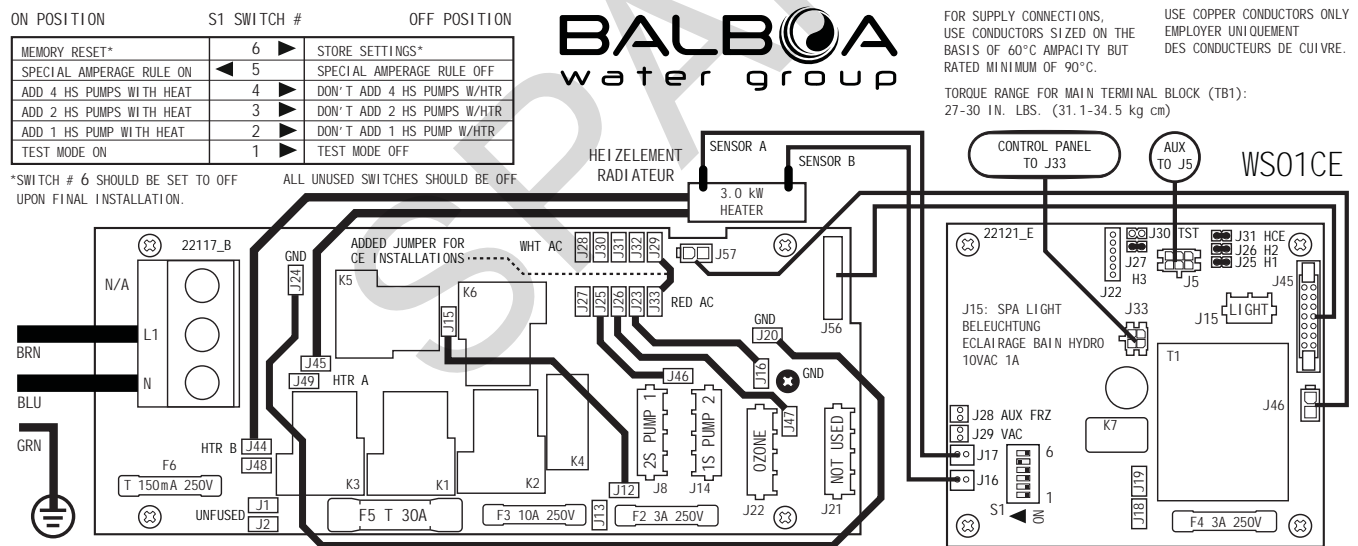

DIP Switch Option

Orig. Setup 1

Changes to

Special Amperage Rule ON. DIP Switch 5 OFF. *DIP Switch 5 ON*

Use this only in cases where there is an overcurrent condition due to pump size.

This setting will not allow Pump 1 High and Pump 2 to run at the same time.

Wiring Diagram - BP600/BP1600, Setup 2-32 as Manufactured

Boards Shown:

Power Board: 22117_B / 56284;

Logic Board: 22121_E / 56131-02

Power Requirements:

Single Service [3 wires (line, neutral, ground)]
 230VAC, 50Hz, 1p, 32A, (Circuit Breaker rating = 40A max.)

System Outputs - 32A Service:

Pump 1	230VAC	2-Speed	12A max	30-minute timer for Low Speed, 15 Minutes for High Speed
This is the heater pump Must deliver a minimum of 20 GPM through heater				
Pump 2	230VAC	1-Speed	12A max	15-minute timer
Ozone	230VAC		.5A max	Uses the same relay as Pump 1 Low
Spa Light	10VAC	On/Off	1A max	4-Hour timer.
Heater	3kW @ 240VAC			
Misc.	J2 & J32	230VAC	4A max	Hot output (Stereo). Fused equipment or in-line fuse required.

Wiring Diagram and Settings

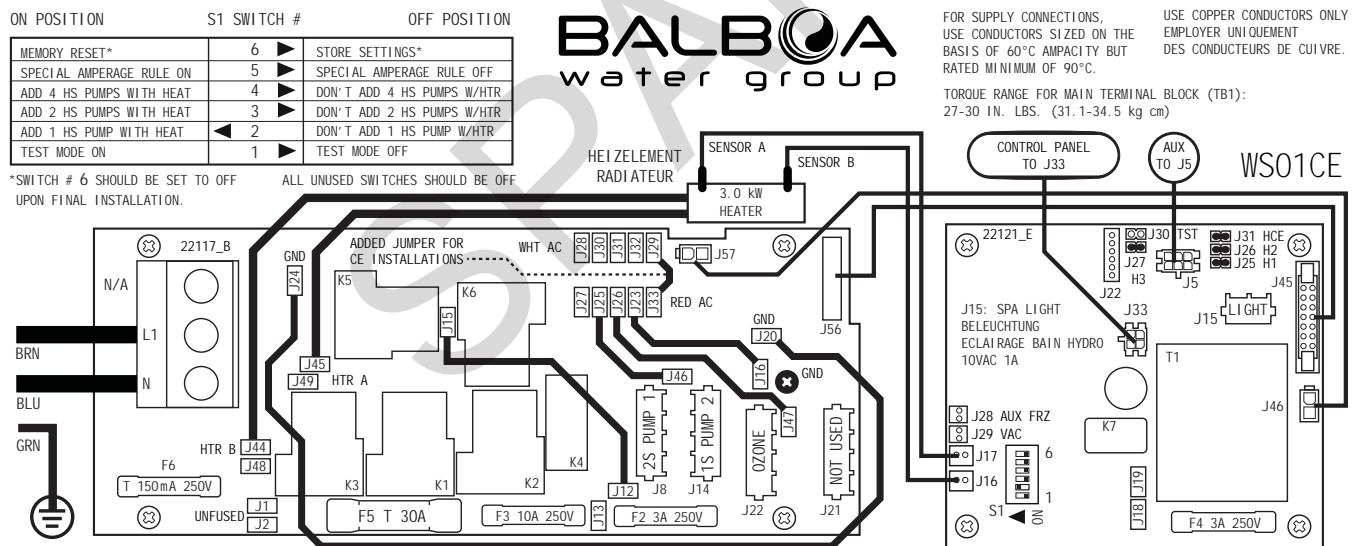

Configuration Changes based on Default Feature

Feature	Orig. Setup 1	Changes to
J2 & J32	Hot Output	Useable
DIP Switch Option	Orig. Setup 1	Changes to
Add 1 High Speed Pump with Heat	DIP Switch 2 OFF	DIP Switch 2 ON

Supplemental Information - Optional Balboa Dolphin™ Remote

THE DOLPHIN™ REMOTE

The Dolphin Remote works much the same way as your entertainment remote at home does; yet, it's designed to control pumps, blowers, and any option that you have on your pool or spa -including entertainment equipment.

HOW THE DOLPHIN WORKS

The Dolphin communicates with a Dolphin RF Receiver (or IR Receiver). The receiver is wired into the Control System.

1. Mount the Dolphin receiver module in a vertical position with the molded arrow pointing up.
2. Plug the receiver's connector into the 6-pin connector J40 labeled REMOTE located within the Control System box.
3. In order for the Dolphin to communicate, it must be assigned an "address" that the Control Center and Dolphin recognize, and allows both the Dolphin and specific equipment (blower, jets, or stereo for example) to "talk" to each other. (The factory default is zero, or no address.)
4. When set to 0, no addressing is used. Use this setting for a Dolphin III, which is factory set for no address by default. The Dolphin has a total of eight addresses: zero, and 1-7.

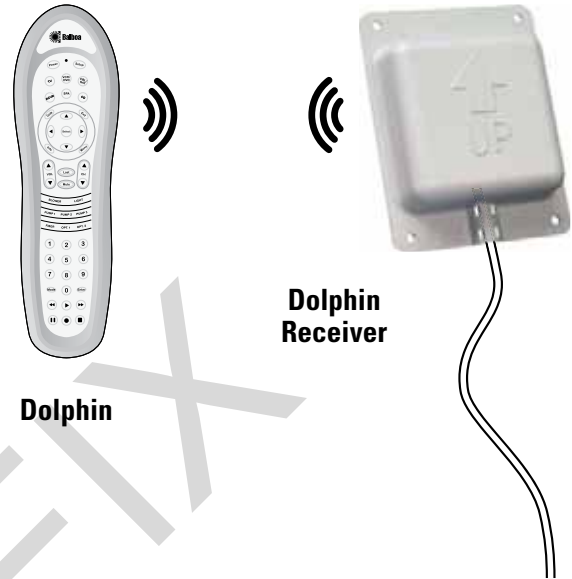

Dolphin

Dolphin Receiver

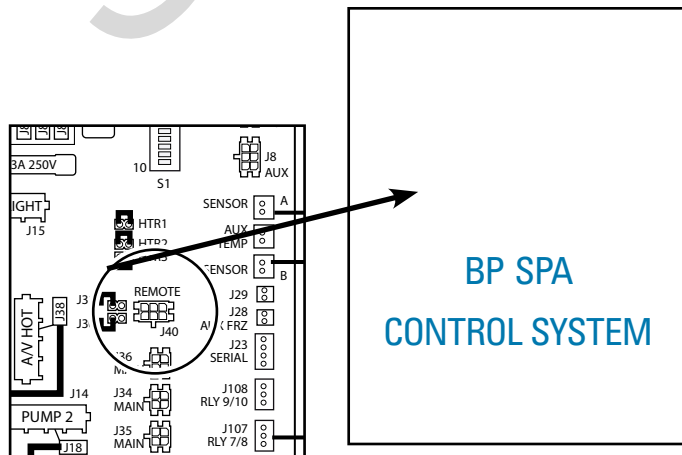

Optional Balboa Dolphin™ Remote (cont.)

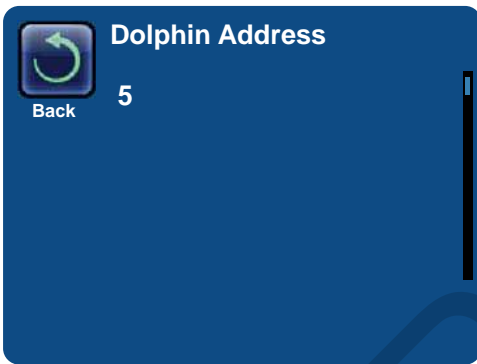

Dolphin III (50211)
Dolphin III CE (50212)

ASSIGNING A NEW ADDRESS TO THE DOLPHIN

In some instances you may want to reset the address of your Dolphin. You'll need to match that new address in the control system and that of your Dolphin.

Step 1: Addressing your Colossus through your control panel:

Main Screen > Settings (scroll to Preferences) > Preferences > Dolphin > Dolphin Screen

Use the arrow key to change the address to 5 (in this example). Exit with Arrow Left key.

Step 2: Addressing your Dolphin:

1. a) Press the SPA Button on the Dolphin once.
b) Press and hold SETUP until the LED blinks once.
c) Hold it until it blinks twice.
2. Enter one of the set up codes below:
Set Up Code = [Spa Address]
0000 = [0] (no address)
0008 = [1]
0080 = [2]
0088 = [3]
0800 = [4]
0808 = [5]
0880 = [6]
0888 = [7]
3. If the code is entered correctly, the LED will blink twice. (Refer to the Dolphin manuals for more details.)

SAVING YOUR DOLPHIN ADDRESS

For future reference, make a note of the address for your records. Keep in mind that you may have to change the address if there are conflicts with your equipment. Also, the address may have to be reentered after servicing.

DOLPHIN MANUAL

Dolphin III manuals can be found on our site: www.balboawatergroup.com

Click on "Spa Products" > "Wireless Remotes"

- Dolphin III manual (domestic) Document No. 42012
- Dolphin III manual (CE) is Document No. 42013

DOLPHIN REMOTES

- Dolphin III (domestic), Document No. 50211
- Dolphin III, CE (no RF), Document No. 50212

Spa Guidelines to Keep in Mind

Below are guidelines when designing replacing an older control system, or if designing a new spa system. This information is included in order to offer more insight into spa plumbing and mechanics.

1. The heater requires at least 20 Gallons per Minute (GPM) of flow for proper function.
2. Some systems may require at least 25 GPM.
3. The suction system for the 2-speed pump or for the circ pump must be dedicated. There must not be any other pumps connected to this suction system.
4. The suction system for the 2-speed pump or for the circ pump must include the following:
 - a. 2 suction fittings, or
 - b. 1 suction fitting and a skimmer.
5. If the suction system for the 2-speed pump or for the circ pump includes a filter, it is desirable that the filter incorporate a by-pass around the filter cartridge that opens when the cartridge gets dirty. (Spring tension holding the by-pass valve closed must be overcome by the vacuum of the pump.) This by-pass should be capable of flowing a minimum of 20 GPM during the low speed operation of the 2-speed pump or during circ pump operation with the cartridge 100% blocked. The inclusion of a suction fitting appropriately plumbed into the suction circuit in conjunction with a vacuum filter may also meet this requirement.
6. The pressure system for the 2-speed pump or for the circ pump must be dedicated. There must not be any other pumps connected to this pressure system.
7. The pressure system for the 2-speed pump or for the circ pump must discharge water freely into the spa.
8. If the pressure system for the 2-speed pump includes a diverter valve, or a diverter jet, there must not be an "off" position that would stop water flow from the pump or any other position that would throttle or reduce water flow from the pump.
9. If the pressure system for the 2-speed pump includes flow adjustable jets that can be 100% closed, at least 2 non-adjustable jets must be included in each possible inlet circuit so that a minimum of 20 GPM can flow during low pump operation with all the jets closed. Any other means of by-passing flow around the closed jets is acceptable as long as the by-pass means is down stream from the heater and allows a minimum of 20 GPM to flow through the heater during low speed operation.
10. If the pressure system for the 2-speed pump includes flow adjustable jets that do not close 100%, at least 20 GPM must flow during low speed operation through each possible inlet circuit with all the jets closed.
11. If the pressure system for a 2-speed pump or for a circ pump includes a filter, the filter must be equipped with a by-pass around the cartridge that opens when the cartridge gets dirty. (Spring tension holding the by-pass valve closed must be overcome by the pressure of the pump.) This by-pass must be capable of flowing a minimum of 20 GPM during low pump operation with the cartridge 100% blocked.
12. If the pressure system for a 2-speed pump or for a circ pump includes branch circulation lines such as circuits intended to operate ozone injection systems, these branch circulation lines must be connected downstream from the heater.
13. Avoid inter-connection of the plumbing circuits for the 2-speed pump or for the circ pump with other pumps in the spa plumbing system for the purpose of freeze protection. The Colossus control system will provide freeze protection. There is also provision for remote sensing freeze protection if required.
14. Position inlets and jets in the spa so that they do not direct water flow towards suction fittings or skimmers. This will avoid a "thermal short circuit" and prevent excessive heater and pump cycling.
15. If service valves are a part of the circulation system for the 2-speed pump or for the circ pump, be sure to use valves that incorporate a means of "locking" in the open position.
16. If the 2-speed pump or the circ pump is replaced in the field by service personnel, the replacement used must equal or exceed the hydraulic specifications of the original pump.
17. To assure adequate performance, the spa plumbing must be 1-1/2" minimum. The use of 2" is highly recommended. Either schedule 40 or flexible PVC pipe is acceptable.
18. It is recommended that shut-off valves be installed in the suction and discharge lines.

Glossary

CIRC PUMP (OR CIRCULATION PUMP)

Low horse power pump designated especially for maintenance of filtration and heating. It often runs all day.

CLEAN-UP (OR PURGE) CYCLE

An action designed to circulate water to maintain sanitary conditions. Pumps or blowers purge standing water to prevent the water from becoming stagnant.

FILTRATION CYCLE

Period of time designated to filter the system. Oftentimes there are two filter cycles, 12 hours apart, and designated as F1 and F2.

FREEZE PROTECTION

A safety feature detecting water or air temperature approaching freezing. Once a set low temperature is reached, an action is often initiated automatically. Oftentimes pumps will start to keep water circulating in all plumbing and the heater may operate.

GFCI

A device intended to protect people in the event of an electrical malfunction. Spa owners should know how to test the GFCI as routine maintenance.

PREFERENCES

Programmed events according to personal preferences.

SSID

Software Self Identification (or, System Panel ID)

PROGRAMMING

Setting an order and time for planned events, such as filter times, clean-up cycle, etc.

PRIMING MODE

Act of water flow through the plumbing to purge air from the spa system. Normally, priming mode can be bypassed. The priming mode is necessary only if the spa is refilled and if there's the possibility of air being in the system.

WHAT PRIMING MODE DOES:

Each time the spa is powered up, it will enter Priming Mode. The purpose of Priming Mode is to allow the user to run each pump and manually verify that the pumps are primed (air is purged) and water is flowing. This typically requires observing the output of each pump separately, and is generally not possible in normal operation. Priming Mode lasts 4 minutes, but you can exit it earlier by pressing any Temp button. The heater is not allowed to run during Priming Mode. NOTE: If your spa has a Circ Pump, it will turn on with Jets 1 in Priming Mode. The Circ Pump will run by itself when Priming Mode is exited.

Index

Symbols

1, DIP Switch 37
 1, Switch 38
 6-pin connector J40 71
 30 - 35 in lbs. torque 41
 30A pump fuses 29
 120V Amp Draw 21
 120 V Draw 21
 120V Watts 21
 230V Amp Draw 21
 230V Watts 21
 240V Amp Draw 21
 240 V Draw 21
 240V Watts 21
 22117_B 69, 70
 22121_E 69, 70
 42012, Document No. 72
 42013, Document No. 72
 50211, Document No. 72
 50212, Document No. 72
 56131-02 69, 70
 56284 69, 70
 ---°F ---°C 53
 °F or °C is replaced by °T 37
 °T 39
 °T, °F or °C is replaced by 37

A

A/B Sensor 37
 A/B Sensor Temperatures 37
 A/B Temps 51
 Acceptable Heater Amperage Draw Ranges 21
 Acceptable Heater Ohm (Ω) Ranges 21, 25
 Acceptable Ranges for Testing 21
 Access, Test Menu 37
 access to the power board 32
 address, Assigning a new 72
 Address, Dolphin 72
 Addressing your Dolphin 72
 Address, Spa 72
 Adequate drainage 2
 AMP cord 34

Amperage Draw Ranges 21
 Amperage Heater Test 33
 Amperage Heater Test BP2100G1 33
 appliance, continuous duty 3
 arrow, right 53
 A, Sensor 37, 51
 Assigning a new address 72
 asterisk, message with an 46
 Auxiliary freeze sensor 47
 A vs B or T vs H 35

B

background colors 54
 ball valves 41
 Blockage*, Pump Suction 59
 Blower, Test the 14
 board, access to the power 32
 Board, Compatibility on Dual 43
 board, expander 29, 44
 Board, Expander 22
 board, isolate the logic 32
 board, Logic 32
 Board, Logic 32, 69, 70
 board, newer revision 43
 Board, Power 69, 70
 board problem 36
 board, reinstalling the 43
 board, Torque main 43
 BP500, Sensor Location 32
 BP2000 board without wires 43
 BP2000/BP2100, Heater Connector on 41
 BP2100G1, Amperage Heater Test 33
 breaker, GFCI 52
 B, Sensor 37, 51
 button, test 52

C

Calls, Service 7
 Canadian Electric Code 3
 Cause 20
 changes, wiring 37
 Change the setup 37
 Checklist, Voltage 21
 Checks, Flow-Related 60

Circ Pump 74
 circulation pump 74
 Circulation Pump Modes 47
 cleanup cycle 48
 Clean-up (or purge) Cycle 74
 Code, Canadian Electric 3
 Code, Fault Message 61
 Code, Message 61
 Code, National Electrical 3
 Codes and Compliance 3
 Code, Set Up 72
 Codes, Fault Log Message 61
 Codes, M0[XX] numbers are Message 46
 Codes, Message 58
 codes, set up 72
 code, system 16
 colder climates 47
 colors, background 54
 Compatibility on Dual Board 43
 compatibility, software 8
 Compliance, Codes and 3
 condition, error 50
 conditions, freezing 52
 configuration, DIP switch for proper 44
 Configuration Settings 37
 Configuration Signature 58
 configurations, setup 37
 configuration, view the 37
 connector, receiver's 71
 connector, sensor 32
 connector, terminal 41
 Connector, Unlock 41
 continue monitoring temperature 50
 continuous duty appliance 3
 continuously, spa to filter 16
 Control System 71
 cord, AMP 34
 Current Setup 37
 cycle, cleanup 48
 Cycle, Clean-up (or purge) 74
 Cycle, Filtration 74
 cycle, second filter 47
 cycles, filtration 47

D

Index

DEMO (Demo Mode) 58
 Demo Mode 37, 51
 Depress sensor tab 32
 Depress tab 35
 Device, Residual Current 2
 different, LCD readouts may look slightly
 58, 59
 DIP Switch 1 37
 DIP switch for proper configuration 44
 DIP switch positions of S1 58
 discolored, slow-blow fuses are not
 always 14
 Document No. 42012 72
 Document No. 42013 72
 Document No. 50211 72
 Document No. 50212 72
 Dolphin 71
 Dolphin Address 72
 Dolphin, Addressing your 72
 Dolphin II 71
 Dolphin III manual 72
 Dolphin receiver 71
 Dolphin™ Remote 71
 Do not pry up 44
 do not pull on the wires 44
 down, spa is shut 59
 dr 59
 drainage, Adequate 2
 Drain Mode 51
 Draw, 120 V 21
 Draw, 120V Amp 21
 Draw, 230V Amp 21
 Draw, 240 V 21
 Draw, 240V Amp 21
 Dry, Heater May be 59
 duration 47

E

End User Warning 2
 error condition 50
 event, fault 61
 exit Priming Mode 38
 exit Test Mode 40
 expander board 29, 44
 Expander Board 22

F

failed, sensor circuit has 53
 FALT LOG (Fault Log) 59
 fault event 61
 fault, ground 52
 Fault Log 37, 49, 51, 61
 Fault Log information 37
 Fault Log Menu 61
 Fault Log Message Codes 61
 Fault Message Code 61
 Fault, Sensor A 53
 Fault, Sensor B 53
 fault, Sensor Balance is Poor 60
 faults, last 24 37
 faults, Stray 35
 Feature, GFCI Test 52
 Filter Cycle 2 48
 filtration 47
 Filtration Cycle 74
 filtration cycles 47
 Filtration, Main 48
 Filtration, Optional 48
 flash, Heat LED will 15
 Flashing Heat LED 15
 flow problem 16
 Flow-Related Checks 60
 Four Pole RCD 17
 freeze protection 47, 50
 Freeze Protection 59, 74
 freezing conditions 52
 fuses, 30A pump 29

G

generator, ozone 47, 48
 GFCI 74
 GFCI breaker 52
 GFCI should be reset immediately 52
 GFCI should trip within several seconds
 52
 GFCI Test Feature 52
 GFCI Trip Test 52
 Glossary 74
 GPM 73
 ground fault 52

guard, VG Compliant suction 2
 Guidelines, Motor Amperage 21
 Guidelines, Spa 73

H

H, A vs B or T vs 35
 Heater Connector on BP2000/BP2100 41
 Heater Flow is Reduced 59
 heater kit with wires 41
 Heater Matrix 21
 Heater May be Dry 59
 heater, no voltage to the 15
 Heater Related Messages 50
 heater, removing a 41
 heater sensor wires 41
 Heater terminal nut installation 41
 Heater Type 21
 Heater Voltage 58
 Heater Wattage as Configured in Software
 58
 heater wires 41
 Heat LED will flash 15
 Heat Waiting 15
 HFL 16, 59
 H_ (Heater Type) 58
 High-Limit Sensor 21
 High Temperature Range 45
 Hot, HTR is too 59
 Hot, Water is too 59
 how to 52
 HTR is too Hot 59

I

Identification, Software Self 74
 ID, Software 50
 ID, System Panel 74
 immediately, GFCI should be reset 52
 Information 49
 information, Fault Log 37
 Information, System 50
 installation, Heater terminal nut 41
 instructions, power connection 2
 Interface, User 8
 Invert 49

Index

IR Receiver 71
isolate the logic board 32

L

last 24 faults 37
latest version 8
Law, Ohm's 23
LCD readouts may look slightly different 58, 59
LED, Flashing Heat 15
lightning strike 14
Limit, Temp 37
Link the panel 38
Lock 49
Locking the Panel 49
Locking the Settings 49
Lock, Settings 49
Log, Fault 37, 49, 51, 61
Logic board 32
Logic Board 32, 69, 70
Low Temperature Range 45

M

M0[XX] numbers are Message Codes 46
M015 53, 60
M016 50, 59
M017 50, 59
M019 59
M019* 46
M020 53, 60
M021 53, 60
M022 53, 60
M026 53, 60
M027 50
M028 50, 59
M029 53, 59
M030 50, 59
M031 60
M031, Sensor A: 53
M032 60
M032, Sensor B: 53
M033 59
M034 53, 60
M035 53, 60

M036 53, 60
M037* 48
Main Filtration 48
manual, Dolphin III 72
Matrix, Heater 21
Menu, Fault Log 61
Menus, Simplified 8, 37, 63
Menus, Standard 8, 37
Menu, System Information 58
Menu, Test 61
Menu, TEST 37
Menu, Utilities 51
Message Code 61
Message Codes 58
Messages 45
messages can be reset from the panel 53
Messages, Heater Related 50
Messages, Scrolling TP400/TP600 59
Messages that can be reset 53
messages will scroll 59
message with an asterisk 46
Miswiring of the spa 14
Mode, Demo 37, 51
Mode, Drain 51
Mode, exit Priming 38
Mode, exit Test 40
Mode, Priming 59, 74
Mode, Ready 47
mode, test 15, 16
Mode, Test 37, 38, 39, 53
Mode., Test 16
MODL (System Model) 58
Motor Amperage Guidelines 21

N

National Electrical Code 3
newer revision board 43
no voltage to the heater 15
nuisance spike 14
Number, Setup 38

O

OHH 59
OHH. 16

Ohms 21
Ohm's Law 23
Ohm Table 21
OHS 59
ON, Switch 1 37
Operation, Restricting 49
Optional Filtration 48
Outs, Time 37
out, Water may splash 41
overlapping filter times 16
ozone generator 47, 48

P

panel, Link the 38
panel, messages can be reset from the 53
panel, software in the topside control 58
panel stops operating 37
panels, TP 8
panels, TP600/TP400 37
panels, TP900/TP800 37
Panel, Unlocking the 49
Parts, Recommended 7
PASS should appear 52
period, time-out 47
Pins, Sensor 36
polling 47
Power Board 69, 70
power connection instructions 2
Preferences 74
pressure, Water under 41
prevent unwanted use 49
Priming Mode 59, 74
Problem 20
problem, board 36
problem, flow 16
problem, sensor 36
problem, suction 59
programmable circ pump 47
Programming 74
Programming Reference 8
properly reset the GFCI 52
protection, freeze 47, 50
Protection, Freeze 59, 74
Pump, Circ 74
pump, circulation 74

Index

pump, programmable circ 47
 Pumps, Troubleshooting 20
 Pump Suction Blockage* 59
 Pump, Test the 14

R

Range, High Temperature 45
 Range, Low Temperature 45
 Ranges, Acceptable Heater Amperage Draw 21
 Ranges, Acceptable Heater Ohm (Ω) 21, 25
 Ranges, Amperage Draw 21
 RCD 2
 RCD, Four Pole 17
 RCD should be tested 2
 RCD, Two Pole 17
 Ready Mode 47
 receiver, Dolphin 71
 Receiver, IR 71
 Receiver, RF 71
 receiver's connector 71
 Recommended Parts 7
 Reduced, Heater Flow is 59
 Ref. Card 40947 8
 Reference, Programming 8
 reinstalling the board 43
 release tab 44
 REMOTE 71
 Remote, Dolphin™ 71
 removing a heater 41
 Replacement Sensor 36
 Required, Service Tools 7
 reset, Messages that can be 53
 reset the GFCI 52
 Residual Current Device 2
 Resistance, Troubleshooting 25, 26
 Restricting Operation 49
 RF Receiver 71
 right arrow 53
 RUN PMPS PURG AIR ---- 59

S

S1 37
 S1, DIP switch positions of 58
 Safety Trip 59
 Screen, Spa 47
 Scrolling TP400/TP600 Messages 59
 scroll, messages will 59
 second filter cycle 47
 Sensor A 37, 51
 Sensor, A/B 37
 Sensor A Fault 53
 Sensor A: M031 53
 sensor, Auxiliary freeze 47
 Sensor B 37, 51
 Sensor Balance is Poor fault 60
 Sensor B Fault 53
 Sensor B: M032 53
 sensor circuit has failed 53
 sensor connector 32
 Sensor, High-Limit 21
 Sensor Location BP500 32
 Sensor Pins 36
 sensor problem 36
 Sensor, Replacement 36
 sensor set 16, 36
 sensor temperatures 16
 Sensor Wires 7
 sequence of tests 14
 Service Calls 7
 Service Tools Required 7
 SETP (Current Setup) 58
 set, sensor 16, 36
 Set Temperature 49
 Settings, Configuration 37
 Settings Lock 49
 setup, Change the 37
 Set Up Code 72
 set up codes 72
 setup configurations 37
 Setup, Current 37
 Setup Number 38
 Setups, Software 37
 shimmer 15
 SIG 58

Signature, Configuration 58
 Simplified Menus 8, 37, 63
 slice valves 41
 slow-blow fuses are not always discolored 14
 software compatibility 8
 Software ID 50
 software in the topside control panel 58
 Software Self Identification 74
 Software Setups 37
 software, test 53, 60
 Spa Address 72
 Spa Guidelines 73
 spa is shut down 59
 spa, Miswiring of the 14
 Spa Screen 47
 spa to filter continuously 16
 spike, nuisance 14
 SSID 50, 74
 SSID (Software ID) 58
 Standard Menus 8, 37
 Stray faults 35
 suction problem 59
 SW _ (Dip Switch Settings) 58
 Switch 1 38
 Switch 1 ON 37
 system code 16
 System, Control 71
 System Information 50
 System Information Menu 58
 System Panel ID 74
 System, Test the 14

T

tab, Depress 35
 tab, Depress sensor 32
 Table, Ohm 21
 tab, release 44
 TB1 18
 Tech Sheets 8
 temperature, continue monitoring 50
 temperature display will alternate 51
 Temperatures, A/B Sensor 37

Index

Temperature, Set 49
 temperatures, sensor 16
 Temp Limit 37
 Temps, A/B 51
 terminal connector 41
 Test, Amperage Heater 33
 test button 52
 tested, RCD should be 2
 Test, GFCI Trip 52
 Testing, Acceptable Ranges for 21
 Test Menu 61
 TEST Menu 37
 Test Menu Access 37
 test mode 15, 16
 Test Mode 37, 38, 39, 53
 Test Mode. 16
 test software 53, 60
 tests, sequence of 14
 Test the Blower 14
 Test the ground fault circuit interrupter
 2
 Test the Pump 14
 Test the System 14
 time-out period 47
 Time Outs 37
 times, overlapping filter 16
 torque, 30 - 35 in lbs. 41
 Torque main board 43
 TP600/TP400 panels 37
 TP900/TP800 panels 37
 TP panels 8
 Trip, Safety 59
 Troubleshooting Pumps 20
 Troubleshooting Resistance 25, 26
 Two Pole RCD 17
 Type, Heater 21

U

Unlock Connector 41
 Unlocking the Panel 49
 User Guide 40940 8
 User Guide 40985 8
 User Guide 42185 8

User Interface 8
 Utilities 49
 Utilities Menu 51

V

valves, ball 41
 valves, slice 41
 version, latest 8
 VG Compliant suction guard 2
 view the configuration 37
 Voltage Checklist 21

W

Waiting, Heat 15
 Warning, End User 2
 Water is too Hot 59
 Water may splash out 41
 Water under pressure 41
 Watts, 120V 21
 Watts, 230V 21
 Watts, 240V 21
 wires, BP2000 board without 43
 wires, do not pull on the 44
 wires, heater 41
 wires, heater kit with 41
 wires, heater sensor 41
 Wires, Sensor 7
 wiring changes 37

Index of Paragraph Topics

0.3A Slo-Blo	7	A fuse with the meter reading “bad”	24
0.3A Slo-Blo	24	A fuse with the meter reading “good”	24
0.15A Slo-Blo	7	All TP Panels have “Molex” Type Connectors.	9
0.15A Slo-Blo	24	Always turn the power off when plugging and unplugging!	36
0.125A Slo-Blo	7	A message with an asterisk [*] can be reset from the topside panel.	46
0.125A Slo-Blo	24	Amperage Draw Ranges	21
3A Slo-Blo	7	Amperage Heater Test BP600.	33
3A Slo-Blo	24	Amperage Heater Test BP2100G1	33
10A	7	A Pump Appears to be Stuck ON – M034	60
10A	24	A Pump Appears to have been Stuck ON when spa was last powered – M035	60
30A	7	A pump may be stuck on – M034.	53
30A	24	A Reset Message May Appear with other Messages.	59
42°F TOO COLD	59	A Simplified Main Menu (Doc No. 42185B).	64
102°F SNSR BAL-- ANCE	60	Assigning a new address to the Dolphin	72
102°T	60	A Standard Main Menu (Doc No. 40940I)	64
120 V Draw	21	Avoid damaging the post. Use an end wrench on the lower nut to reinforce the post when removing the upper nut.	42
240 V Draw	21	Be sure that both clamps are not making contact with anything below the insulating material on the terminal (arrows).	31
20600	7	Be sure to set the Time-of-Day	47
20600	24	BE SURE TO TURN THE POWER OFF BEFORE REPLACING ANY COMPONENT, ESPECIALLY A CIRCUIT BOARD.	44
21581	7	BETA VER-- SION -----	60
21581	24	BP600 board Setup switch	38
26281	7	BP2100 board screw locations	43
26281	24	BP2100 board without wires	43
26397	7	BP2100 Circuit Board	7
26397	24	Brown Outs	13
30122	7	Brown to Blue Wires on a 230V BP600 System	28
30122	24	Brown to Blue Wires on a 230V BP2100 System	28
30136	7	BWG Part Number.	7
30136	24	BWG Part Number.	24
A / B (A/B Sensor Temperatures)	58	CE Product:	52
A/B Temps	51	Changing Menus Through Configurations	63
A/B Temps (A/B Sensor Temperatures)	37	Check for Loose Connections or Damaged Wires	18
Acceptable Heater Amperage Draw Ranges	21	Checking the System Power Input Fuse.	13
Acceptable Heater Ohm (Ω) Ranges	21		
Acceptable Heater Ohm (Ω) Ranges	25		
A common programming mistake is overlapping filter times that may cause the spa to filter continuously.	16		

Index of Paragraph Topics (cont.)

Circ Pump (or circulation pump)	74	F6 and F8 are on the main board. F1 is located on the expander board.	29
Circulation Pump Modes	47	F6 Fuse	13
Cleanup	54	F6 to TB1 Blue	29
Cleanup Cycle (optional)	48	FALT LOG (Fault Log)	37
Clean-up (or purge) Cycle	74	FALT LOG (Fault Log)	59
CLOCK FAIL -----	60	Fault Log Message Codes: TP400, TP600.	61
CNFG FAIL -----	60	Fault Log: tp800, tp900	51
Color of Background	54	-----°F ----- °C	59
Communications error.	53	---°F ---°C	53
Compatibility on Dual Board Control Systems	43	Filter Cycle 2 - Optional Filtration	48
Configuration Error - Spa will not Start Up	53	Filtration and Ozone	47
Configuration Error - Spa will not Start Up	60	Filtration Cycle	74
Configuration Signature	50	Flashing Heat LED on TP600 ("Heat Waiting")	15
Continuity	23	Flow-Related Checks	50
Current Setup	50	Flow-Related Checks	60
DEMO (Demo Mode)	37	Forcing the GFCI Trip Test.	52
DEMO (Demo Mode)	58	°F or °C is replaced by °T	53
Demo Mode	51	°F or °C is replaced by °T	60
Depress sensor tab when removing	32	Four Pole RCD	17
Depress tab when removing	35	Freeze condition	16
Device	21	Freeze Protection	47
Dip Switch Settings	50	Freeze Protection	74
Disconnect the connector by depressing the tab.	25	Fuse	7
Dolphin	71	Fuse	24
Dolphin II and Dolphin III (Applies to RF Dolphin only)	54	Fuses Used on BP spa Systems	7
Dolphin III (50211)	72	Fuses Used on BP spa Systems	24
Dolphin III CE (50212)	72	GFCI	74
Dolphin Manual	72	GFCI FAIL -----	60
Dolphin Receiver	71	GFCI Failure - System Could Not Test/Trip the GFCI – M036	60
Dolphin Remotes	72	GFCI Test (Feature not available on CE rated systems.)	51
Do not measure across heater terminals	30	Ground in System Enclosure	12
DO NOT REMOVE AND REPLACE THE CIRCUIT BOARD UNLESS THE FAULT HAS POSITIVELY BEEN DETERMINED TO BE THE CIRCUIT BOARD.	44	Heater Assembly	7
Drain Mode	51	Heater Connector on BP2000/BP2100 Series	41
Exiting Priming Mode	46	Heater Element Specifications Are Shown on the Heater Tube Label	9
Exiting Priming Mode	57	Heater Flow is Reduced (HFL) – M016	59

Index of Paragraph Topics (cont.)

Heater Flow is Reduced (LF)* – M017	59	MO[XX] numbers are Message Codes.	46
Heater Matrix	21	M-7 Replacement Sensor	36
Heater May be Dry (dr)* – M028	59	Main Filtration.	48
Heater Related Messages	50	Measure resistance from a heater post to the heater housing	26
Heater Start Up Information	15	MEM FAIL -----	60
Heater Type	50	Memory Failure - Checksum Error* – M022	60
Heater Voltage (Feature not used on CE rated systems.)	50	Memory Failure - Clock Error* – M020	60
Heater Voltage (Feature not used on CE rated systems)	58	Memory Warning - Persistent Memory Reset* – M021	60
Heater Wattage as Configured in Software (CE Systems Only)	50	MEM RSET -----	60
Heater Wattage as Configured in Software (CE Systems Only)	58	Message Codes	16
Heater Wires on a BP500/BP600 Series system are connected to the lower Power Board.	42	Message Codes	58
Heat LED in Heat Waiting Mode, TP600	15	Messages	45
H _ (Heater Type)	58	MODL (System Model)	58
Hold Mode - M037*	48	Most messages and alerts will appear at the bottom of the normally used screens.	53
HOT FALT ----- CALL FOR SRVC -----	60	Most Probable Overheating Causes, Inspect These First.	16
Hot fault – M035	53	Motor Amperage Guidelines	21
How the Dolphin Works.	71	Navigation	45
htr flow fail -----	59	NO COMM.	60
htr flow loss -----	59	No Communications.	60
HTR is too Hot (OHH)* M030	59	Note: Be careful when removing a heater assembly from a spa plumbing system. Water may splash out under pressure. See next page for more illustrations.	41
HTR MAY BE DRY ----- WAIT -----	59	Note: These are typical settings only. Voltages may be different depending on the configuration that the system is set to. See the system's Tech Sheet for more information.	34
HTR TOO HOT -----	59	Observe safety at all times	27
If the problem stays with the same sensor (according to topside messages) it's a board problem; if the problem moves to the other sensor it's a sensor problem.	36	Ohm's Law.	23
Important -- Use of non-copper wire	18	Once the power input fuse has been changed	13
INFO (System Information sub-menu).	58	On Every System, an Identification Label Is Placed on Top of the Casing.	9
Installing a System Circuit Board	43	On Every System, a Wiring Diagram Is Placed Inside the Door	9
Language	54	Panel Version	50
Locate the heater connector.	25	PANL (Panel Version)	58
Locate the heater connector.	26	Place clamp around one heater wire, and then the other wire.	33
Locking nuts are in the same location on other BP models	42	Place the meter probes on the heater terminals.	25
Logic Board: 22121_E / 56131-02	69	Possible freezing condition	53
Logic Board: 22121_E / 56131-02	70	Power Board: 22117_B / 56284;	69
Logic Jumper, No. 20618	7		
Low Voltage	13		

Index of Paragraph Topics (cont.)

Power Board: 22117_B / 56284;	70	Sensor A Fault, Sensor B Fault – Sensor A: M031, Sensor B: M032 53	
Preferences	54	Sensor Balance is Poor – M015.	60
Preferences	74	Sensor Balance is Poor* – M026	60
Preliminary Panel Check.	15	Sensor Failure – Sensor A: M031, Sensor B: M032	60
Preparation and Filling	46	Sensor Location BP500, on Logic Board	32
Preparation and Filling	57	Sensor Pins: At times, a protective coating may on accident coat the sensor pins during manufacturing. Those pins may need to be scraped and the sensors plugged back in.	36
Pre-Production Software	60	Sensors are out of sync -- Call for service* – M026	53
PRES BTTN TO RSET -----	59	Sensors are out of sync – M015	53
Press-and-Hold	45	Service Tools Required	7
Priming Mode	74	SETP (Current Setup)	58
Priming Mode –	46	sfty trip -----	59
Priming Mode – M019	59	Side View: Depress Tab to Unlock Connector	41
Priming Mode – M019*	57	SIG (Configuration Signature).	58
Priming the Pumps	46	Simplified Menus	63
Priming the Pumps	57	SNSR A ----- CALL FOR SRVC -----	60
Program memory failure* – M022	53	SNSR B ----- CALL FOR SRVC -----	60
Programming	74	SNSR SYNC ----- CALL FOR SRVC -----	60
Pull the connector straight out.	25	Software ID: (SSID)	50
Pull the connector straight out.	26	Software Setups	37
Pump 1 AMP cord	34	Software Setups (BP2100)	40
Pumps	47	Some Troubleshooting Scenarios.	16
Purge Cycles.	48	Spa Status	45
RCD Line-in Wiring Check.	19	SSID	74
RCD Line-out Wiring Check for 230 V Dedicated System	19	SSID (Software ID)	58
Recommended Parts to have For Service Calls	7	STUK PUMP -----	60
Release tab	25	SW _ (Dip Switch Settings).	58
Reminders	54	System Box Wire Gauge Check.	18
Remove both nuts that secure the element in place.	42	System Information	50
Removing a System Circuit Board.	44	System Model	50
Removing BP Expander Board, an Alternate Way	44	TB1	13
Restricting Operation (Locking the Panel).	49	TB1	18
RUN PMPS PURG AIR ----	59	Temp Display	54
Safety Trip - Pump Suction Blockage* – M033.	59	Temperature & High-Limit Sensor Ohm Table	21
Saving Settings	47	Temperature Sensors location (Wires removed)	35
Saving Your Dolphin Address	72		
Scrolling TP400/TP600 Messages	59		

Index of Paragraph Topics (cont.)

Temp Limit.	37	The water is too hot – M029	53
Terminal Block & F5 Fuse on a BP600 Power Board, 230V Setup	13	This would typically show high speed voltage for Pump one. (230V)	34
Terminal Block & F6 Fuse on a BP2100 Board	13	This would typically show low speed voltage for Pump one. (230V)	34
Testing a Fuse: Check continuity with the fuse removed.	24	Time Display	54
Testing low speed and High Speed at the AMP Connector	34	Time Outs	37
Testing Sensor Pins	36	Tip: If one sensor (A or B) seems to be having problems, swap the cables of sensor A with sensor B.	36
Test Menu Access (S1, Switch 1 ON).	37	To Determine the Cause of a Blown Power Input Fuse.	14
Test Mode.	16	Too Cold - Freeze Protection	59
Test software installed	53	TP400/TP600 error codes and fault messages are similar to TP800/TP900.	55
Test the Amperage Draw	14	Troubleshooting Heater Posts Resistance to Heater Housing	26
Test the Blower	14	Troubleshooting heater Resistance	25
Test the Pump	14	Two Pole RCD	17
Test the System.	14	Unlocking the Panel	49
The brown wire should connect to load out, the blue wire from neutral out. All wires will exit the box via conduit routed to the spa control system.	19	Used for verifying a proper installation.	52
The clock has failed* – M020	53	Utilities menu	51
The Control System is in Test Mode if 102°T appears. (In this case °F or °C is replaced by °T.)	37	Verifying Incoming Voltage at the Terminal Block.	28
The Dolphin™ Remote	71	Verify that there is no heater “leakage”	26
The Fault Log	61	Verify there is NO continuity from the heater post to the ground/earth. On the resistance scale, the a digital meter should read OL (indicating infinite resistance).	26
The GFCI test failed (System Could Not Test the GFCI) – M036	53	Verify there is NO continuity from the heater post to the heater housing or heater current collector connection. The meter reading shown is OL, indicating infinite resistance.	26
The Ground Fault Circuit Interrupter (GFCI).	52	Viewing Configuration Settings.	37
The heater is dry* – M027	50	Voltage Checklist	21
The heater is too hot* – M030	50	Water is too Hot (OHS) – M029.	59
The heater may be dry* – M028	50	Water Temperature is Unknown	53
The Logic Board must be removed to access and remove the heater wires, shown in red.	42	Water Temperature is Unknown	59
The preferred way to check for fuse continuity is with the fuses removed from the circuit.	24	watr too hot -- -- --	59
There are three 30A pump fuses in the BP2100G1 spa control system.	29	What Priming Mode does:	74
These readings should be taken under peak load conditions.	14	Wiring Check Precautions.	18
The settings have been reset (Persistent Memory Error)* – M021	53	With the pump high speed ON, take a voltage reading at the AMP receptacle on the PCB.	34
The Utilities Menu contains the following:	54	With the pump low speed ON, take a voltage reading at the AMP receptacle on the PCB.	34
The water flow has failed* – M017	50		
The water flow is low – M016	50		

