



# 2007 HYDROPOOL swim spa owner's manual



**HYDROPOOL**  
swim spas

HydroPool Industries:

Tel: 905.565.6810

Toll Free: 1.800.465.2933

Fax: 905.565.6820

Email: [info@hydropoolhottubs.com](mailto:info@hydropoolhottubs.com)

[www.hydropoolhottubs.com](http://www.hydropoolhottubs.com)

[info@spafix.dk](mailto:info@spafix.dk) - [www.spafix.dk](http://www.spafix.dk)

**SPAFIX**

# TABLE OF CONTENTS

<b>Letter of Introduction</b> .....	3	<b>Topside Control Panel Display Messages</b> .....	40
<b>Important User Safety instructions</b>		<b>Jet and Feature Operation</b>	
Warnings .....	4	Jet Water Flow Adjustment.....	42
Hyperthermia .....	4	Jet Air Flow Adjustment .....	42
<b>Choosing the Right Location</b>		Jet Insert Removal & Replacement.....	42
Indoor Locations.....	5	Interchanging Jet Inserts.....	42
Outdoor Locations.....	5	Adjustable Flow Control (Diverter) Valves.....	43
<b>General Installation Considerations</b> .....	6	<b>Swim Spa Water Balance</b>	
<b>Special Considerations for</b>		General Overview.....	44
Indoor Installations .....	6	Glossary of Common Water Maintenance Terms .....	45
Outdoor Installations .....	6	Water Balance Summary Chart .....	45
<b>Site Preparation for</b>		Signs of Improper Water Balance.....	46
Above ground installations .....	7	<b>Corona Discharge Ozone Technology</b> .....	46
Partial in-ground installations .....	7	<b>Suggested Routine Water Maintenance</b>	
In-ground installations.....	8	Initial Fill.....	47
Equipment accessibility.....	8	Daily, Weekly, Monthly, Annually .....	47
<b>Remote Equipment Placement and Plumbing</b>		Chemical Safety Hints.....	47
Remote Equipment – General.....	9	<b>Cleaning the Skimmer Basket</b> .....	47
Remote Above-Grade Equipment.....	9	<b>Cartridge Filter</b>	
Remote Equipment Plumbing Diagrams .....	9	Removal, Cleaning, Re-Installation .....	48
<b>Unloading/Handling Your Swim Spa</b> .....	10	<b>Cleaning the Acrylic Surface</b> .....	48
<b>Leveling Your Hydropool Swim Spa</b> .....	11	<b>Safety Hard Cover</b> .....	48
<b>Set-up and Assembly</b>		<b>Changing Your Swim Spa Water</b> .....	49
Steel Support Leg Assembly – Overview.....	11	Formula.....	49
Steel Support Leg Assembly – Details.....	12	Water Softeners .....	49
Support Equipment Assembly .....	13	<b>Draining Your Swim Spa Water</b> .....	49
Ozonator Connection .....	13	<b>Wood Cabinet</b>	
Light Bulb / LED Assembly.....	14	Factory Cabinet (Optional) Assembly.....	50
TopSide Control Panel Connection.....	14	Protecting Your Cabinet Wood Finish.....	50
<b>Important Electrical Safety Instructions</b> .....	14	Cabinet Wing-Locks.....	50
North America – GFCI installation.....	15	<b>Winterizing Your Swim Spa</b> .....	51
Europe – R.C.D. installation.....	16	<b>General Troubleshooting</b> .....	52
<b>Swim Jets Pump(s) Timer – Europe Only</b> .....	17	<b>What to do in the event of...</b>	
<b>Installing Accessories</b>		Power fluctuations.....	53
Corner Wrap Pillow.....	18	Cold weather power failure .....	53
Aquacord Tether System .....	18	<b>Notes</b> .....	53
Filter Cover.....	18		
Mood Lighting.....	19		
Safety Hard Cover Locks .....	19		
Cover Remover – Optional.....	19		
<b>Filling, Checking and Starting Your Swim Spa</b> .....	20		
Pump Priming/Releasing an Air Lock.....	21		
<b>Hydropool Control Systems</b>			
<b>North America</b>			
Aquatrain Series.....	22		
Aquatrain Series with Remote Equipment .....	26		
Aquaplay Series .....	30		
<b>Europe</b>			
Aquatrain and Aquasport Series.....	33		
Aquaplay Series .....	37		

Since manufacturing our first swim spa in 1995, we have seen the popularity of this mini-fitness and massage pool grow by leaps and bounds year after year.

HydroPool swim spas are not only fun and relaxing, they can even add value to your home.

The minimal space and maintenance requirements of swim spas, combined with the year-round use potential, safety and better swim, will ensure the future of swim spas as "the pool of the future".

This manual contains valuable information and pointers that will save you both time, money and help simplify upkeep and maintenance.

Please take the time to carefully read and understand all the safety, installation and operating instructions in this manual before electrically connecting your swim spa and adding water.

Enjoy.

David Jackson  
President



# SAVE THESE INSTRUCTIONS

## IMPORTANT USER SAFETY INSTRUCTIONS

Your physiological response to hot water is subjective and depends on your age, health, and medical history. If you don't know your tolerance to hot water, or if you get a headache, or become dizzy or nauseous when using your swim spa, get out and cool off immediately.

### WARNINGS



- 1 Children should NOT use a swim spa without alert adult supervision.
- 2 Children should not enter a swim spa where water temperature exceeds body temperature (37°C / 98.6°F).
- 3 As prolonged immersion in water temperatures in excess of 38°C (100°F) may be injurious to your health, we recommend measuring the water temperature with an accurate thermometer before entering the swim spa. We also recommend establishing lower temperatures and shorter use periods for young children and/or those users potentially affected by hot temperatures. Recommended Water Temperature 27 – 29°C (80 – 85°F).
- 4 Do not allow children to submerge their head under water.
- 5 Do not use a swim spa unless all suction guards are installed to prevent body and hair entrapment. Do not sit in front of, or on top of the suction fittings or skimmer, as this will obstruct proper circulation and may result in personal injury.
- 6 Never operate the swim spa pumps at high speed without having all suction and return lines open.
- 7 Always keep the hardcover installed and locked when the swim spa is not in use.
- 8 People using medications and/or having any adverse medical history should consult a physician before using a swim spa.
- 9 People with infectious diseases should not use a swim spa.
- 10 Exercise caution when entering or exiting a swim spa. Where practical, install a safety grab bar or handrail. Turn off the jets before entering the swim spa to improve visibility of the steps or flat entry area.
- 11 To avoid unconsciousness and possible drowning, do not use drugs or alcohol before or during the use of a swim spa.
- 12 Pregnant woman should consult a physician before using a swim spa.
- 13 Do not use a swim spa immediately following strenuous exercise.
- 14 Do not permit or use electric appliances (such as a light, telephone, radio or television) within 1.5 m (5 ft) of this swim spa, unless such appliances are rated at 12VDC or less.
- 15 Test the GFCI (Ground Fault Circuit Interrupter) monthly.
- 16 Post emergency phone numbers for Police, Fire Dept., and Ambulance at the nearest phone.
- 17 Maintain water chemistry/balance in accordance with manufacturer's instruction

### HYPERTHERMIA

Since your swim spa can be set to reach temperatures of 40°C (104°F), users should be aware that extended submersion in water that exceeds normal body temperature can lead to hyperthermia.

The causes, symptoms and effects of hyperthermia may be described as follows:

Hyperthermia occurs when the internal temperature of the body reaches several degrees above the normal body temperature of 37°C (98.6°F). The symptoms of hyperthermia include drowsiness, lethargy, and an increase in the internal temperature of the body. The effects of hyperthermia include:

- Unawareness of impending hazard
- Failure to perceive heat
- Failure to recognize the need to exit the swim spa
- Physical inability to exit the swim spa
- Fetal damage in pregnant woman
- Unconsciousness resulting in the danger of drowning

If you sense any of the symptoms of hyperthermia, safely exit the Swim Spa immediately.



### WARNING

THE USE OF ALCOHOL, DRUGS OR MEDICATION CAN SIGNIFICANTLY INCREASE THE RISK OF FATAL HYPERTHERMIA.

**NEVER ALLOW DIVING OR JUMPING  
IN YOUR SWIM SPA**

## CHOOSING THE RIGHT LOCATION

Your HydroPool swim spa can be installed indoors or out, on the ground, in the ground or half-and-half. The following information will assist you in choosing the right location for your individual needs. When making your decision, always remember that a swim spa can be enjoyed year-round, indoors or out, regardless of the climate. Many HydroPool owners report that their favourite time to use a swim spa is in the cooler fall and winter months, while others praise the enjoyment of using their swim spa in the warmer spring and summer months.

### INDOOR LOCATIONS

If members of your family are not cold weather enthusiasts, or if your backyard or patio area is not suitable for a swim spa installation, then an indoor location for your swim spa may be your best or only choice. You may wish to create an exercise/spa area in your home, or install your swim spa in a glass solarium or four-season room adjoining your home.

Indoor installations not only add a unique look and appeal to your home, they provide the privacy and controlled climate to ensure that use and enjoyment of your swim spa is maximized.

Where the swim spa is being recessed, or a custom deck or tile is being installed, the cost savings of being able to order a swim spa without a cabinet is another benefit of choosing HydroPool.

If you should choose an indoor location, you will find further information as outlined in the section - "SPECIAL CONSIDERATIONS FOR INDOOR INSTALLATIONS" - p.6



### OUTDOOR LOCATIONS

For a variety of reasons, outdoor locations are a far more popular choice. Some of the reasons include:

- Limited indoor space
- Delivery complications due to limited indoor access.
- Limited budget (indoor installations usually also involve interior home renovations)
- Desire for an outdoor entertainment center
- Swim spa is being installed adjacent to an existing or planned swimming pool
- Concerns over splashing water inside the home

For those who choose an outdoor location, swim spa operating temperatures can be adjusted to match the season. In colder months, some owners will operate their swim spa in the range of 32-35°C (90 - 95°F). During warmer months, an operating temperature of 27-29°C (80-85°F) will provide a refreshing retreat.

If you should choose an outdoor location, you will find further information as outlined in the section - "SPECIAL CONSIDERATIONS FOR OUTDOOR INSTALLATIONS" - p. 6

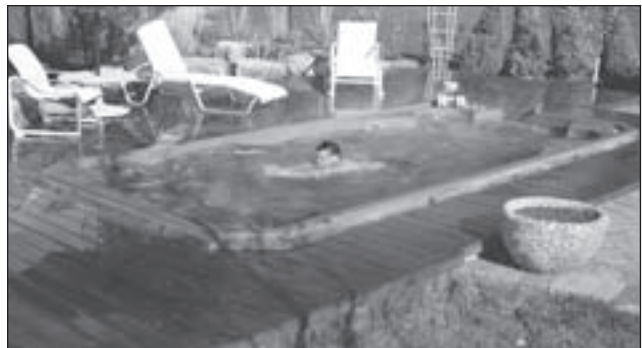

## GENERAL INSTALLATION CONSIDERATIONS

- Ensure that your HydroPool swim spa is properly supported by either a level concrete pad, or a properly constructed deck capable of supporting 925 kg/m<sup>2</sup> (200 lbs./ft.<sup>2</sup>). If there is a possibility that the pad could shift by freezing/thawing ground movement (such as in clay regions, and/or areas with high water tables) concrete footings extending below the frost line are recommended.
- If you are installing the optional knockdown cabinet, building your own custom cabinet or decking, please consider the following:
  - Your HydroPool swim spa, with steel support legs, is self-supporting on its base. The cabinet is decorative only, and not to be used for support.
  - Always provide a convenient access door for servicing the equipment.
  - Decking should be constructed to allow future service access around the entire swim spa.
  - Extra insulation may be added however, the equipment area must remain unimpeded and have adequate ventilation.
  - Decking should be chosen and constructed in a manner that minimizes the chance of slipping or falling
- The equipment and all electrical plugs, outlets and lights within 1.5 meters (~5 feet) of the pool must be G.F.C.I protected. **The steel support legs must be grounded.** Consult your electrician for further details.
- Access to the swim spa must be secured. Outdoor installations, by an approved fence with a self-closing gate and a safety hardcover, indoor installations, by a lockable door and a safety hard cover. **Refer to local codes and bylaws regarding pool fencing.**
- Installation of a safety grab rail or reachable support for use when entering or exiting the swim spa is recommended.
- A nearby garden hose connection is recommended for filling and "topping up" your swim spa.
- Additional side-wall support of the unit is not required when installed with the (optional) steel support legs. Swim spas installed in the ground and properly backfilled, will not require the steel leg support package, however, some installers prefer to use these in all installations.



Never suspend the swim spa from a deck or cabinet as personal injury and/or product damage may occur.



Anti-entrapment devices may be required in some regions. Please check your local building codes.

## SPECIAL CONSIDERATIONS FOR...

### INDOOR INSTALLATIONS

- Where the swim spa is to be installed indoors, and where ceiling height is 3 m (10 feet) or less, we recommend that the swim spa be fully or partially recessed into the floor. This will allow sufficient headroom for safe entry into, or exit from, the swim spa.
- It is beneficial to have the swim spa room located near a washroom and shower facility.
- The swim spa room should have a floor drain to handle any splash water, and a window or outside exhaust fan complete with humidistat for ventilation. Where this is not practical, the use of indoor/outdoor carpeting or a tile floor and the opening of a window and/or the use of a room dehumidifier while the swim spa cover is removed should suffice.
- **Always provide adequate ventilation for the support equipment**
- Consult your local dealer for further information

### OUTDOOR INSTALLATIONS

- Contact your local building code department to determine if a building permit is necessary and for information on applicable bylaws (distance from property lines, buildings, fencing requirements, etc). In some instances the shallow depth of the unit could result in the swim spa being classified as a swim spa by building regulations (as opposed to a pool).
- If you are doing any excavating contact your local gas, electric and cable company to ensure that there are no underground lines.
- Locate the swim spa, where practical, within close proximity to a door to the house to maximize potential winter use.
- Ensure that your pump(s), controls, and drain valve are easily accessible and protected.
- The swim spa equipment is designed for indoor out of the direct elements use. If your HydroPool swim spa is equipped with a factory designed knockdown cabinet, and installed as per the guidelines of this manual, the equipment will be adequately protected. **If your swim spa has been ordered without a cabinet, your custom cabinet or other structure must be designed to provide protection for the swim spa support equipment from rain, snow, splash water, etc., but still designed in a manner to ensure adequate ventilation.**
- Ensure that any opening to the equipment and the working area around the equipment is large enough to accommodate a service person.
- If the swim spa equipment is to be remotely located, above the fill water level (19 mm [3/4 in] from top of skimmer) a REMOTE ABOVE-GRADE EQUIPMENT PACKAGE and additional plumbing will be required.
- The surface surrounding the swim spa (decking, tile, concrete, etc.) must slope away from the unit to allow for proper water run-off.

## SITE PREPARATION FOR...

### ABOVE-GROUND INSTALLATIONS

Where the swim spa is a "stand-alone" above-ground installation to be installed in regions where freeze/thaw conditions may occur, a patio stone or pre-formed paver type pad may be sufficient if there is no abutting deck(s) that could be damaged during potential seasonal movement of the ground. The potential drawback to this type of base is that splash water could eventually de-stabilize the ground under the pad, with the resultant shift of the support base causing damage to the structure.

For best results, we suggest the installation of a **LEVEL** concrete pad:

- Dig out and level the ground 20-30 cm (8-12 in.) below your desired base level
- Install 10-15 cm (4-6 in.) of crushed stone

- Next, install 10-15 cm (4-6 in.) of poured concrete
- Level the concrete and apply a broom-type finish

Recommended Minimum Concrete Pad Dimensions		
	With Factory Cabinet & Steps	Without Cabinet
14 ft. Model	259 cm x 576 cm 102 in x 228 in	239 cm x 488 cm 94 in x 192 in
17 ft. Model	259 cm x 671 cm 102 in x 264 in	239 cm x 576 cm 94 in x 228 in

In regions where freeze/thaw occurs, or where there will be custom decking abutting the swim spa, we recommend the installation of poured concrete footings extending below the frost line beneath the pad to prevent the possibility of future shifting.

### INSTALLATION EXAMPLES

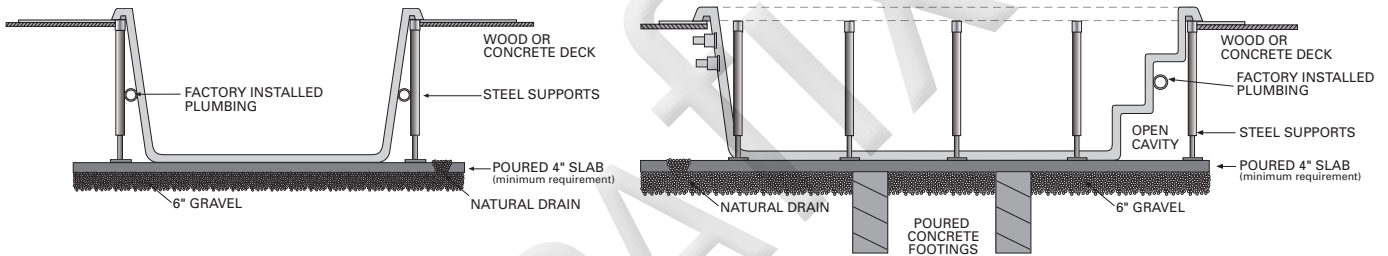

### PARTIAL IN-GROUND INSTALLATIONS

For units being installed fully or partially in the ground, the type of support will again vary based on whether or not the swim spa is being installed in an area where freeze/thaw conditions may occur.

- **Non-freezing climates** – it is sufficient to ensure that the base of the hole or cavity created for the swim spa simply has a stable, compacted base. Where the climate permits, should you choose to backfill directly against the swim spa, a clear sand backfill is suggested and therefore, the steel support legs are not required
- **Climates where freeze/thaw occurs** – it is necessary that a proper poured concrete base, complete with concrete footings, be installed as outlined in the section, ABOVE-GROUND INSTALLATIONS
- **Areas with a high ground water table** – the concrete base, as well as a concrete or wood retaining wall to hold back the earth, is suggested. This forms a box or 'crib', in which the swim spa is placed
- ALWAYS ensure that there is good drainage, via a properly designed French (gravel) drain system and/or a sump pump, to prevent ground water flooding damage to the support equipment or structure – see section IN-GROUND INSTALLATIONS – p. 8
- Install protective waterproof conduit to house light, or topside control cables that must be buried
- Access for future service must be considered at the time of design and installation. Difficult access can result in supplemental service labour charges not covered by the factory warranty. Consider easily removable deck materials.

### INSTALLATION EXAMPLES

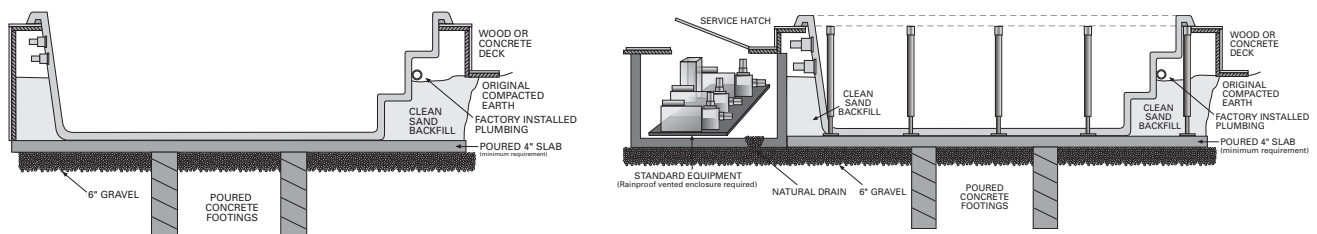

## SITE PREPARATION FOR...

### IN-GROUND INSTALLATIONS

- When recessing the swim spa all or part way below ground level, a concrete base along with a concrete or wood retaining wall to hold back the earth is suggested. This forms a box or 'crib', in which the swim spa is placed.

Recommended Minimum Interior Dimensions		
Application	14 ft. Model	17 ft. Model
Crib No Backfill	150 in x 240 in 381 cm x 610 cm	150 in x 276 in 381 cm x 701 cm
Pit With Backfill	259 cm x 549 cm 102 in x 216 in	259 cm x 640 cm 102 in x 252 in

- Where the climate permits, should you choose to backfill directly against the swim spa, a clear sand backfill is suggested

### INSTALLATION EXAMPLES

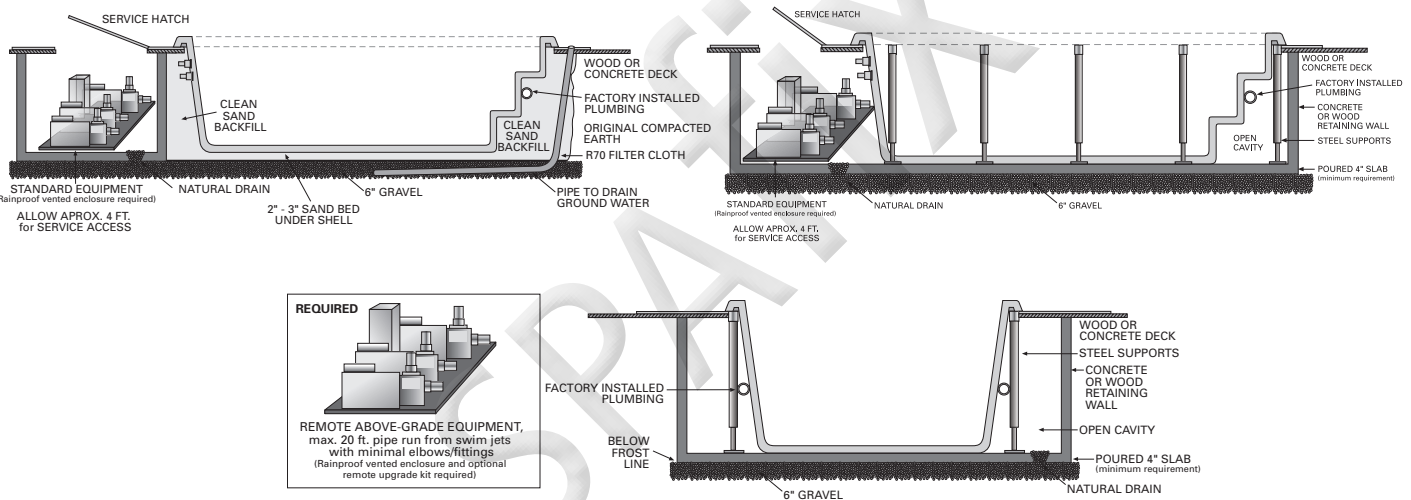

### EQUIPMENT ACCESSIBILITY

The equipment must be located in an area where it will remain dry and will not be exposed to rain, snow or ground water.

- When your swim spa is to be installed above ground, the optional factory cabinet is designed for both protection and accessibility
- When your swim spa is to be installed fully or partially in the ground, if you are relocating the equipment remotely from the swim spa, or if you have ordered a swim spa without a cabinet: it is necessary that the equipment be installed in an area that is dry, protected from the elements, has proper ventilation, and is easily accessible for service
- Always ensure that the equipment is mounted on a raised base or platform to prevent water damage to the motors, equipment or controls. Note that the equipment is supplied on a raised composite support equipment platform.
- Ensure that the opening to the equipment, and the working area around the equipment, is large enough to accommodate a service person

- Install protective waterproof conduit to house light, or topside control cables that must be buried
- Ensure ample air space under air control(s) for proper function. A minimum space of at least .03 cubic metres (1 cubic foot) of open space per air control is recommended. For air control locations see JET & FEATURE OPERATION - p. 43
- ALWAYS ensure that there is adequate drainage via a properly designed gravel drain system and/or a sump pump to prevent ground water flooding damage to the support equipment
- Access for future service must be considered at the time of design and installation. Difficult access can result in supplemental service labour charges or damage to your decking. Consider easily removable deck materials.
- It is recommended leaving a 61 cm (24 in) wide crawl-space around the entire unit to ensure adequate accessibility.

- The equipment should be located as close to the swim spa as possible to maximize jet performance

Whenever possible, install the pump(s) below water level to ensure easy priming. Where above-grade equipment location is necessary, ensure that your swim spa is equipped with the optional REMOTE ABOVE-GRADE EQUIPMENT PACKAGE.

Install protective waterproof conduit to house applicable cords or line extensions such as the topside control cables, light wires or ozone tubing. In climates where freeze/thaw occurs we suggest that remote piping be buried below the frost line and that pipe insulation is applied over all pipes that run from the swim spa to the remote equipment to maintain energy efficiency.



## REMOTE EQUIPMENT PLACEMENT & PLUMBING

### REMOTE EQUIPMENT – GENERAL

The following should be considered to ensure easy access for service and maintenance where the equipment is being installed in a remote location:

- The distance from the unit should never exceed 6.09 m (20 feet) of pipe length, otherwise jet performance will be affected.
- Piping diameter on pump lines must be 2.5 in. for inlet/suction pipes and 2 in. for outlet/pressure pipes with minimal use of elbows.
- In cold weather climates all piping should be insulated to minimize heat loss.
- All air tubing, control cables and light wires should be run through a protective conduit to avoid problems associated with ground shifting.
- The swim spa equipment is designed for indoor/out of the direct elements use. If your HydroPool swim spa is equipped with a factory designed knockdown cabinet, and installed as per the guidelines of this manual, the equipment will be adequately protected. If your swim spa has been ordered without a cabinet, your custom cabinet or other structure must be designed to provide protection for the swim spa support equipment from rain, snow, splash water, etc., but still designed in a manner to ensure adequate ventilation.

### REMOTE ABOVE-GRADE EQUIPMENT

In the event that you are plumbing your equipment in a remote location where the support equipment will be higher than the swim spa fill water level, you should have purchased the optional REMOTE ABOVE-GRADE EQUIPMENT PACKAGE consisting of:

- 1 Self-priming pumps with strainer basket
- 2 Topside control panel extension with booster
- 3 Light niche and extension

The provision of any required extra plumbing or fittings is the responsibility of the installer.

- The equipment should not be located further than 6.09m (20 feet) from the swim jets, and must be placed in a dry, vented area, easily accessible for service.
- The equipment should not be installed more than 30 cm (12 in.) higher than the swim spa fill water level.
- All field installed plumbing must meet minimum sizes previously outlined in order to conform to regulated standards regarding safe inlet and outlet flows. If required, please call your dealer for more detailed drawings.
- Ensure that the topside control panel, light and any other cables are protected within conduit before backfilling.

Please note: the hair and lint strainer basket on the remote above-grade equipment pumps can be removed for improved flow.

### REMOTE EQUIPMENT PLUMBING DIAGRAMS

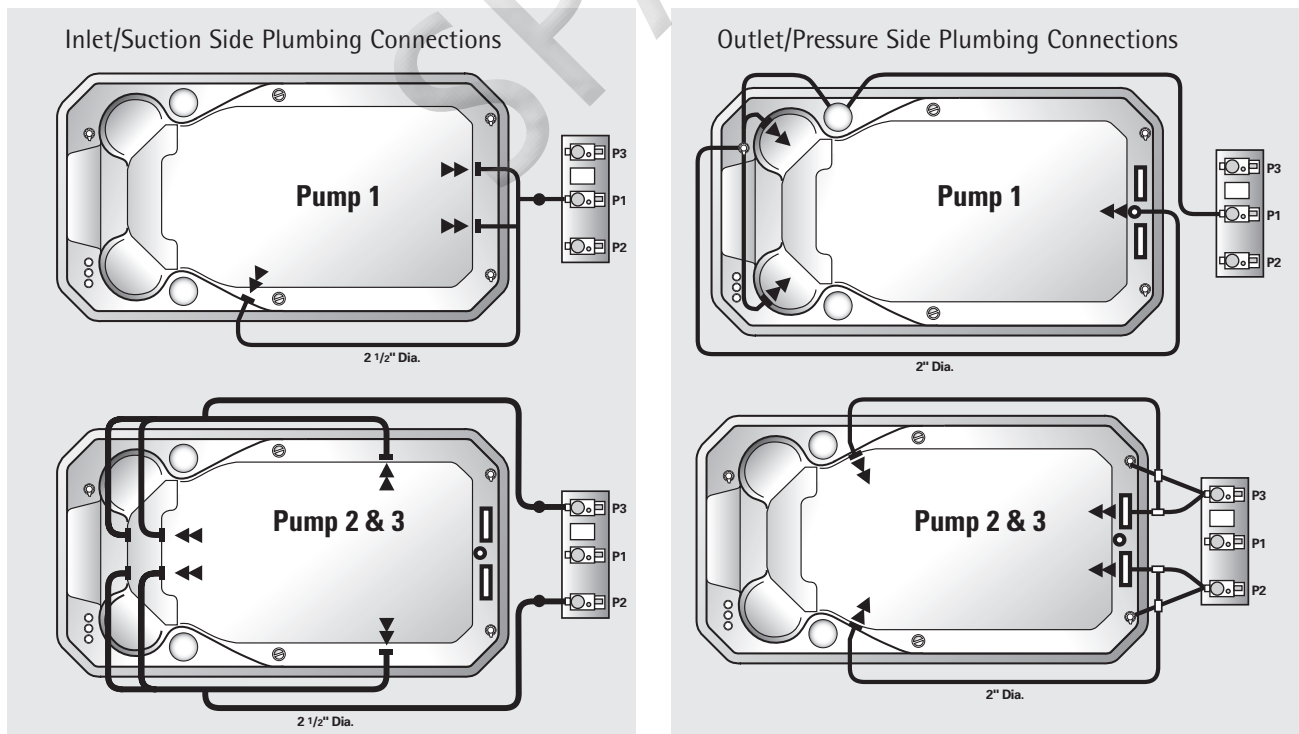

## UNLOADING / HANDLING YOUR SWIM SPA

All HydroPool swim spas are shipped with a layer of protective foam wrap and plastic film. Each swim spa is factory strapped onto a wood skid. If your swim spa is to be delivered by your local dealer, it will generally arrive on a flat bed truck or low profile trailer. Typically, the dealer will arrive with the necessary equipment to maneuver the swim spa from the truck.

For direct deliveries, your swim spa will arrive on a 48 ft. or 53 ft. common carrier closed box trailer. It may be necessary to arrange with a local towing company for a tilt and load flatbed truck with a winch system, to pull the unit from the box trailer to the flatbed. The swim spa can then be gently slid off the flatbed truck or lifted by a crane into place.

Your swim spa may be either hand carried/rolled by 10 to 12 able-bodied adults, trailered, or craned to its final installation site. If rollers are to be utilized, we recommend that at least six 4" pipes, 8' long, be placed under the shell to move it across a soft lawn, down a path, etc.

Some installations require the use of a crane. When a crane is used for lifting, place the straps under the swim spa, and

whenever possible, in between the plumbing and the shell (to avoid damaging the plumbing). The straps should be secured so that they will not slip in any direction, and strap spreaders utilized to prevent undue structural side load on the swim spa shell.

HydroPool swim spas require a minimum clearance of 249 x 130 cm (98 x 51 in.) to allow movement of the unit through alley-ways, fence openings, etc. Where this is not possible, the use of a crane (with strap spreaders) to lift the swim spa from the truck or trailer over the house to the patio or yard is often the most viable option.



- Do not move or place the swim spa on its sides or ends as damage could occur
- Never lift or handle the swim spa by the plumbing as this will cause leaks
- Make sure that there is sufficient assistance to gently slide the swim spa off of the dolly or cart to the support base without any damage

### COMMON DELIVERY ARRANGEMENT EXAMPLES

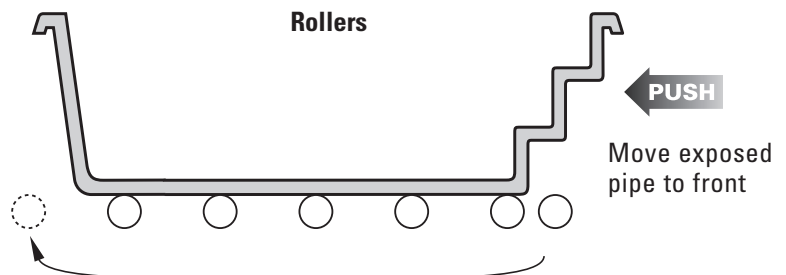
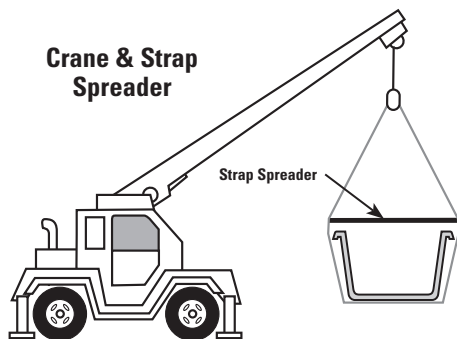
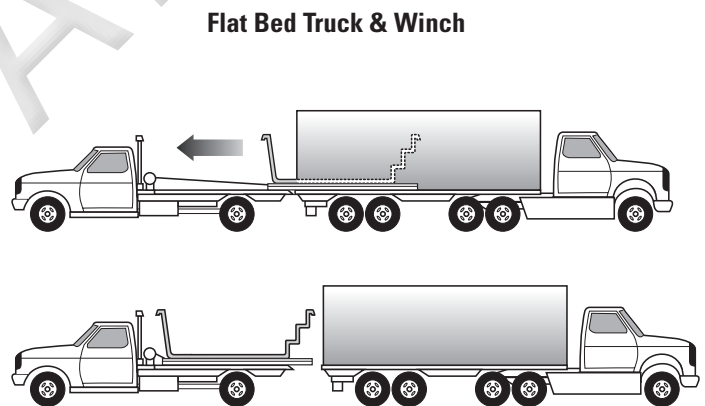
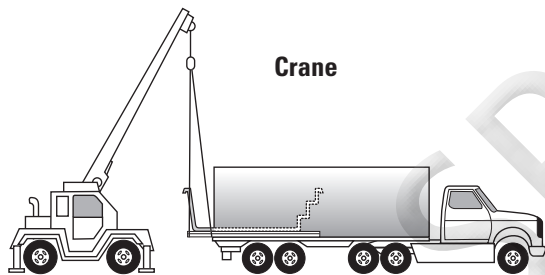

## LEVELING YOUR HYDROPOOL SWIM SPA

After the swim spa is properly positioned on the support base, the entire unit should be checked and leveled as necessary. Should you find that the unit is sloped or the base is otherwise uneven, level your swim spa using a 2" – 3" sand bed. Make sure to enclose or 'box-in' the sand to prevent erosion. This will ensure contact with the support

substructure to appropriately distribute the weight of the swim spa structure. Do not JUST shim under the outside edge, as this will cause structural stress on the unit, potentially causing damage to the swim spa structure.

## SET-UP & ASSEMBLY

Set-up of your swim spa will vary depending on whether you have purchased an Aquatrainer, Aquaplay, or Aquasport model. Once your swim spa is set into place, you are ready to install the steel support legs and connect the equipment package.

### STEEL SUPPORT LEG ASSEMBLY

Do not tighten or adjust steel support legs until water is added to the swim spa. Refer to FILLING, CHECKING AND STARTING YOUR SWIM SPA - p. 20 for final adjustment(s).

### STEEL SUPPORT LEG ASSEMBLY OVERVIEW

14' unit = 9 legs

17' = 11 legs

- 1 Threaded post - protrudes below swim spa lip
- 2 Foot Assembly - includes foot plate & two hex nuts
- 3 Hex Nut Assembly
- 4 Square support leg

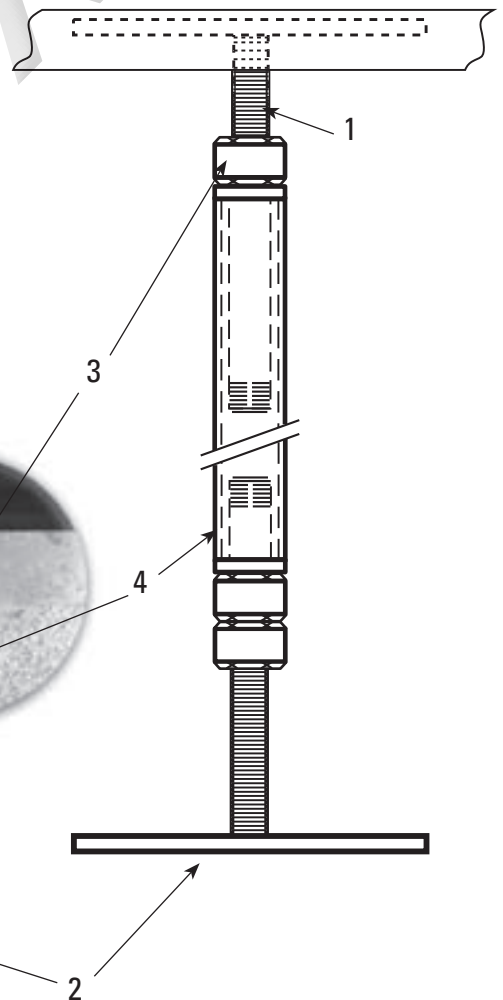

**STEEL SUPPORT LEG ASSEMBLY DETAILS**

1 Thread one hex nut all the way up to the top of the threaded posts attached under the lip.

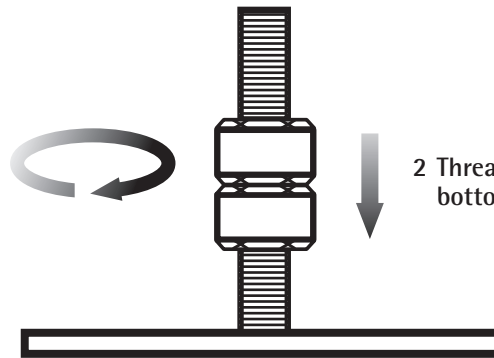
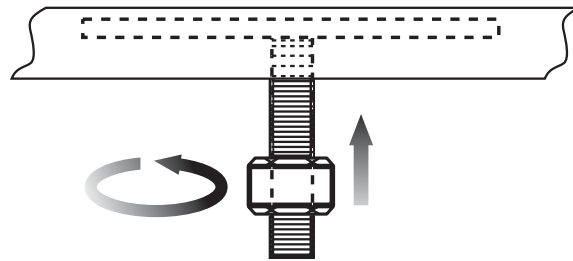

2 Thread two hex nuts down to within 2.5 cm (1 in.) of bottom of foot plate

3 Slide the foot plate assembly onto one end of the square support leg, then slide the leg onto the threaded post under the swim spa lip.



4 Bring the two hex nuts on the foot plate up about 5.1 cm (2 in.) and the hex nut on the threaded post under the swim spa lip, down about 5.1 cm (2 in.). Finger tighten until the leg is secure.

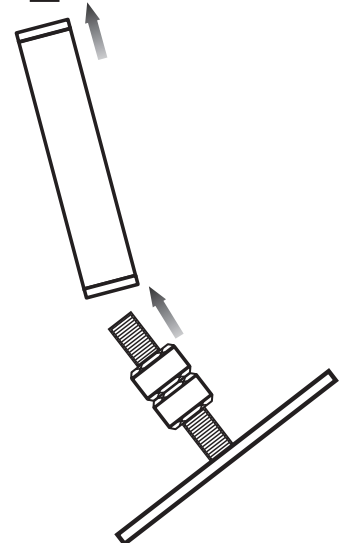
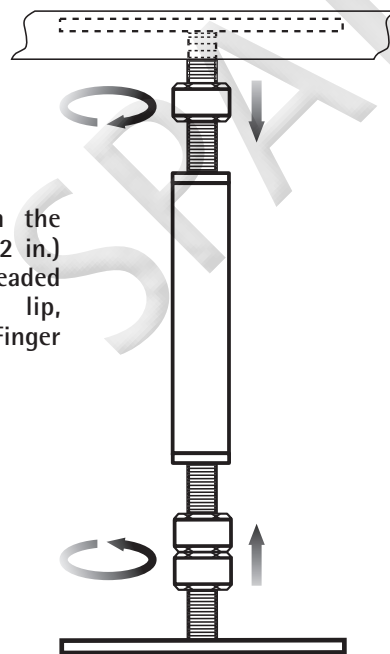

5 After the swim spa is filled with water, the legs can now be adjusted as necessary from either the top or bottom with a wrench to ensure that the walls are straight and level. See section FILLING, CHECKING & STARTING YOUR SWIM SPA - p. 20



**WARNING**  
 DO NOT OVER-EXTEND THE STEEL SUPPORT LEGS AND/OR SUSPEND SHELL ABOVE THE FLOOR AS THIS WILL CAUSE STRUCTURAL DAMAGE AND VOID WARRANTY

**SUPPORT EQUIPMENT ASSEMBLY**

Position equipment platform next to the swim spa under the swim jets. **Do not remove support equipment from platform.** All necessary o-rings are bundled and shipped in the accessories bag. Carefully install all o-rings into

unions and hand tighten. Ensure that o-rings are properly seated and do not get pinched while connecting the unions as this will result in leaks. Union connections are located on the swim spa control heater manifold, pipe to pipe connections and all pumps.

**AQUATRAINER/AQUASPORT SUPPORT EQUIPMENT PLATFORM – TYPICAL (EUROPEAN VERSION SHOWN)**



**AQUAPLAY SUPPORT EQUIPMENT PLATFORM – TYPICAL (NORTH AMERICAN VERSION SHOWN)**

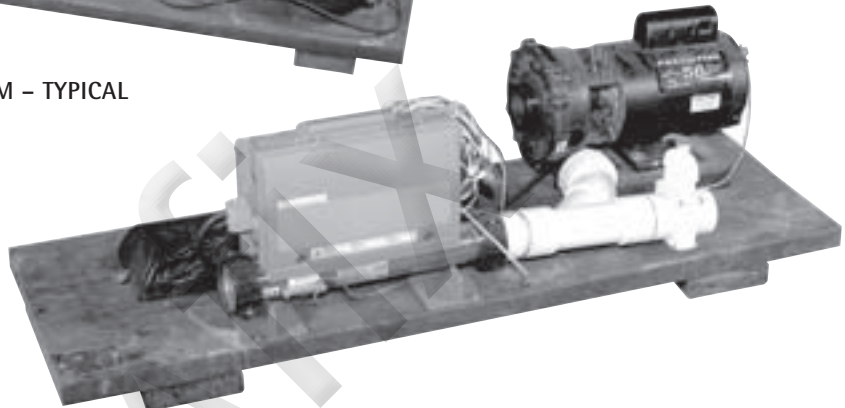

**REMOTE ABOVE-GRADE EQUIPMENT PACKAGE NORTH AMERICA ONLY – TYPICAL**

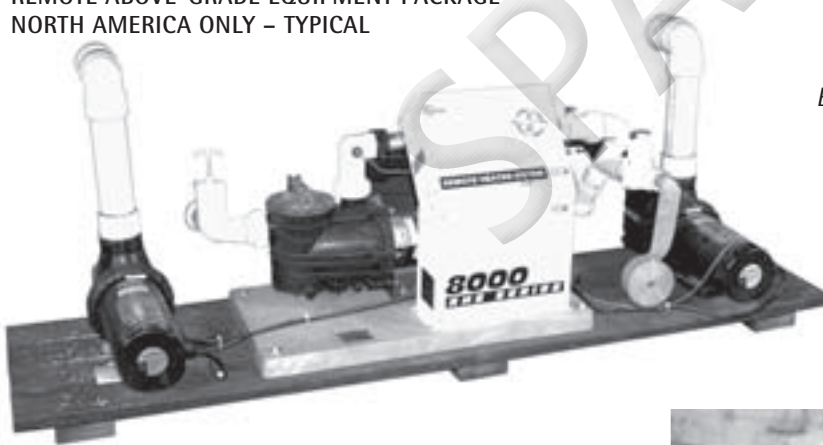

*Equipment may not be exactly as shown.*

**OZONATOR CONNECTION**

The clear 9.5 mm (3/8 in) ID ozonator tube is shipped coiled and attached to the back of the swim jets. Attach loose end to barb on ozonator.



### LIGHT BULB/LED ASSEMBLY

The light wire harnesses are bundled & attached to the control box on the equipment platform. One light is located on the riser of the middle step and the other is located under the swim jets. You will need to attach the light at the swim jet end only. Thread the plastic light housing onto the clear housing. Ensure bulb/L.E.D. is secure in the socket.

Note: Aquaplay model has one light at step end



### TOPSIDE CONTROL PANEL CONNECTION

Connect the topside control panel extension cable (located on equipment platform) to main topside control cable located under the control panel.



## IMPORTANT ELECTRICAL SAFETY INSTRUCTIONS

SAFETY COMES FIRST. WHEN INSTALLING & USING THIS ELECTRICAL EQUIPMENT, BASIC SAFETY PRECAUTIONS SHOULD ALWAYS BE FOLLOWED

- 1 READ AND FOLLOW ALL INSTRUCTIONS
- 2 Electrical installation must be performed by qualified persons only (electrician or equivalent) in accordance with local electrical codes.
- 3 Connect only to a dedicated circuit protected by a class 'A' two-pole ground fault circuit interrupter (GFCI)
- 4 Use copper conductors only!
- 5 The Swim spa equipment and all electrical plugs, outlets and lights within 1.5m (5ft) of the unit must be G.F.C.I protected. Consult your electrician or local electrical authority for further details.
- 6 A green colored terminal or a terminal marked "G", "GR", "Ground", or "Grounding" is located inside the supply terminal box or compartment. To reduce the risk of electric shock, this terminal must be connected to the grounding means provided in the electric supply service panel with a continuous copper wire equivalent in size to the circuit conductors supplying the equipment.
- 7 At least two lugs marked "BONDING LUGS" are provided on the external surface or on the inside of the supply terminal box or compartment. To reduce the risk of electric shock, connect the local common bonding grid in the area of the swim spa to these terminals with an insulated or bare copper conductor not smaller than No.6 AWG (Canada/Europe) / No.8 AWG (USA).
- 8 All field installed metal components such as rails, ladders, drains or other similar hardware within 3 m (10 ft) of the swim spa shall be bonded to the equipment grounding bus with copper conductors not smaller than No.6 AWG. The steel support legs must be grounded.

### WIRE SIZE

#### NORTH AMERICA

- The *minimum* wire size for systems that require a 40A GFCI is #8/3 c/w ground (also referred to as #8 gauge/4 conductor).
- The *minimum* wire size for systems that require a 50A or 60A GFCI is #6/3 c/w ground (also referred to as #6 gauge/4 conductor).

#### EUROPE

- The *minimum* wire size for European system is 2.5 mm<sup>2</sup> copper wire.

### G.F.C.I./R.C.D. APPLICATION GUIDE

#### NORTH AMERICA

Aquatrainer	60A
Aquaplay	40A

#### EUROPE

All models (single-phase)	40A
---------------------------	-----

### IMPORTANT NOTE:

- This guide is for standard installations where the wire run is 15 m (50 ft.) or less. For longer wire runs, consult a qualified electrician.

## NORTH AMERICA – GFCI INSTALLATION



**Important Note:** Installation of the GFCI - Circuit Breaker, including ampere sizing and selection of conductor size and type, must be performed by a qualified electrician in accordance with the **National Electrical Code**, or the **Canadian Electrical Code**, and all Federal, State/Provincial and local codes and regulations in effect at the time of installation.

### SIEMENS - TYPICAL

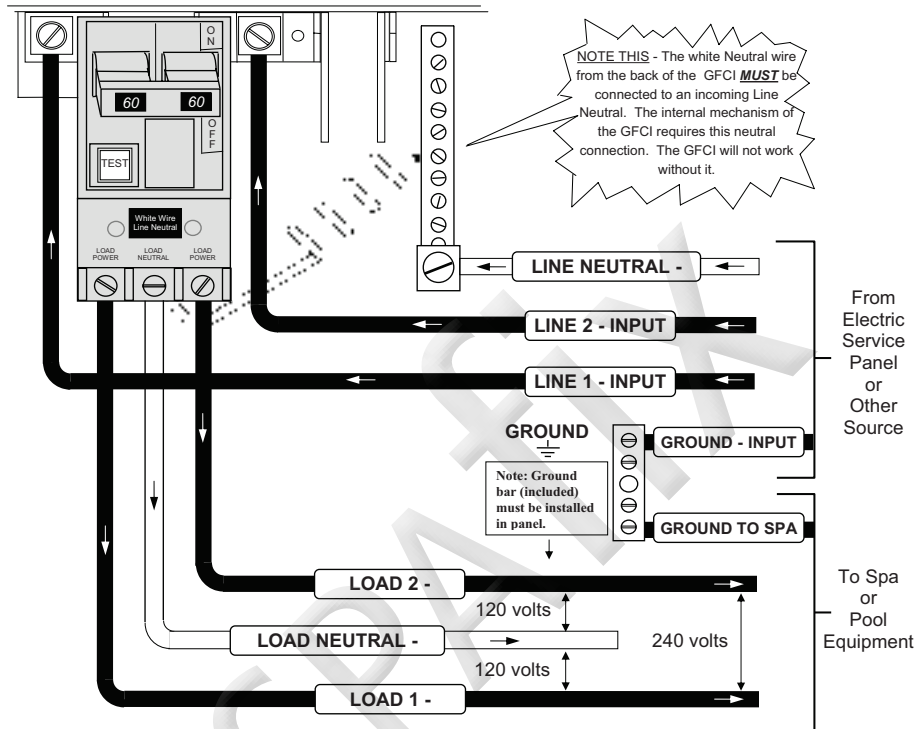

### SQUARE D - TYPICAL

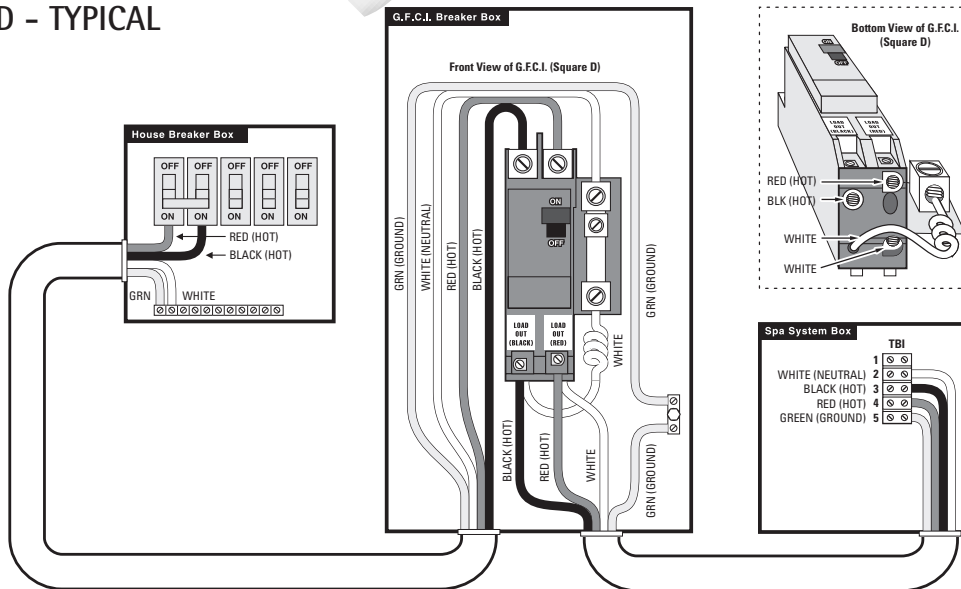

## EUROPE – R.C.D. INSTALLATION - TYPICAL

**Important Note:** Installation of the R.C.D. - Circuit Breaker, including ampere sizing and selection of conductor size and type, must be performed by a qualified electrician in accordance with National, Regional and Local Codes and Regulations in effect at the time of installation.

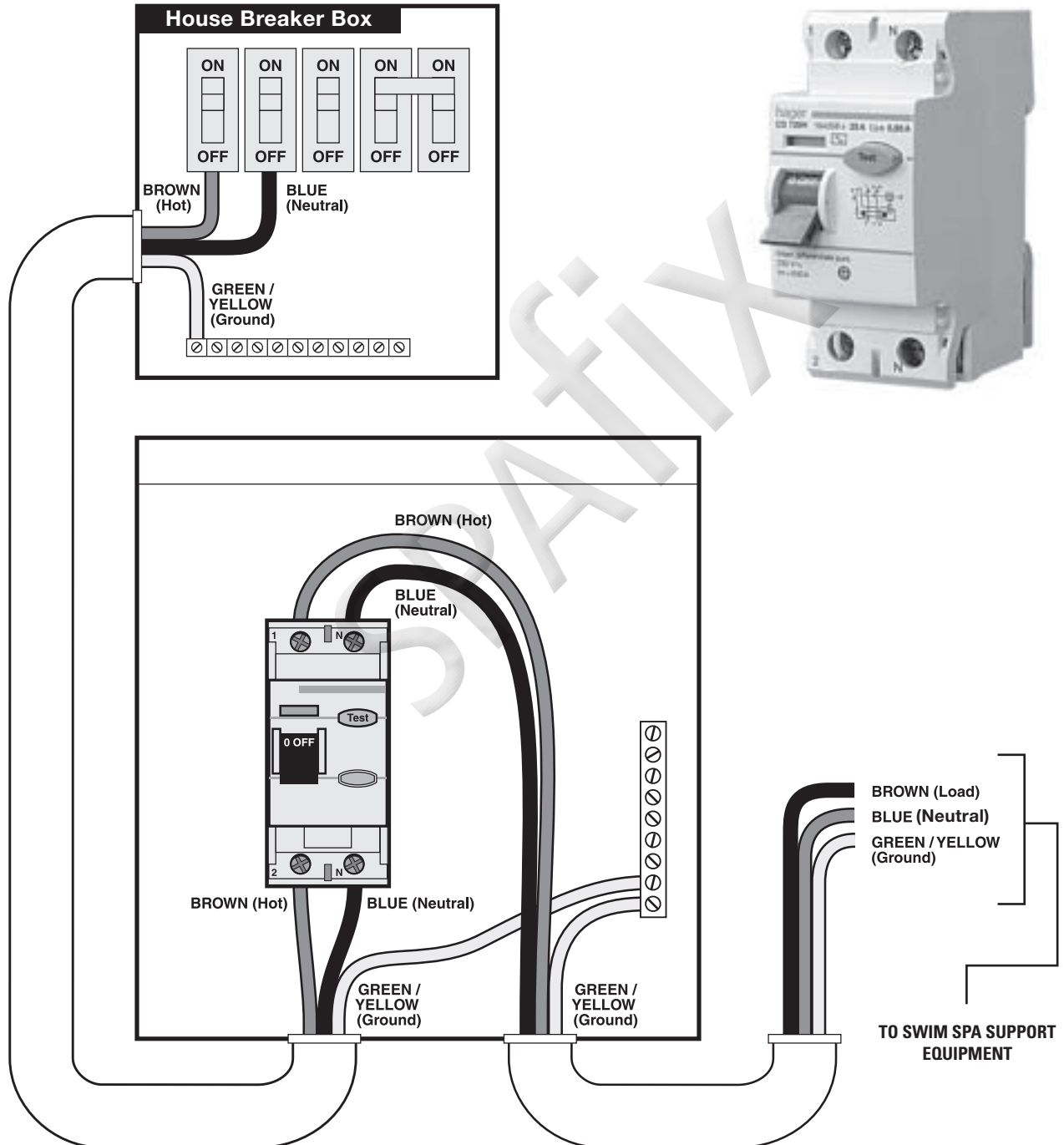



## SWIM JETS PUMP(S) TIMER – EUROPE ONLY

In some regions of Europe, a separate control is required for the swim jets pump(s) in order to conform to local electrical requirements. This control is designed to operate with either a 1-Phase or 3-Phase dedicated line input, and utilizes a single pneumatic air button to control the swim jet pump(s). Typical installations are illustrated below.

### INPUT SERVICE

230VAC, 1-Phase or 400VAC, 3-Phase (neutral required)

### RATING

50Amp resistive load.

### OPERATION

The first push of the air button turns ON pump(s) and pressing again turns OFF pump(s). The control automatically turns OFF the pump(s) after 30 minutes.



- Use copper conductors only
- Do not lubricate relays
- All controls must be installed by a licensed electrician according
- Always refer to specific installation instructions located on inside cover of equipment

SINGLE-PHASE INSTALLATION – 220V

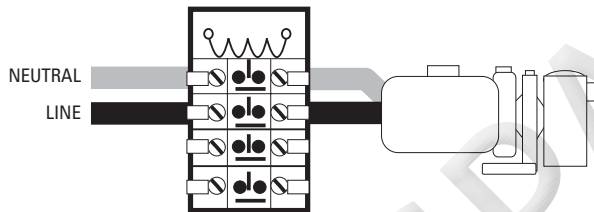

1 OR 2 MOTORS UP TO 5 HP EACH

THREE-PHASE INSTALLATION – 400V or 380V

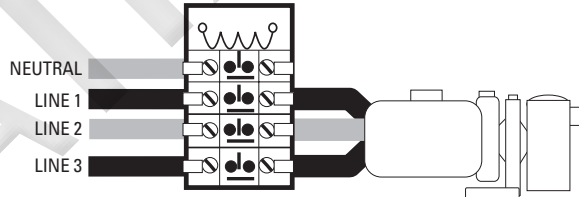

1 MOTOR UP TO 10 HP

**IMPORTANT:** NEUTRAL AND LINE 1 MUST BE 230VAC

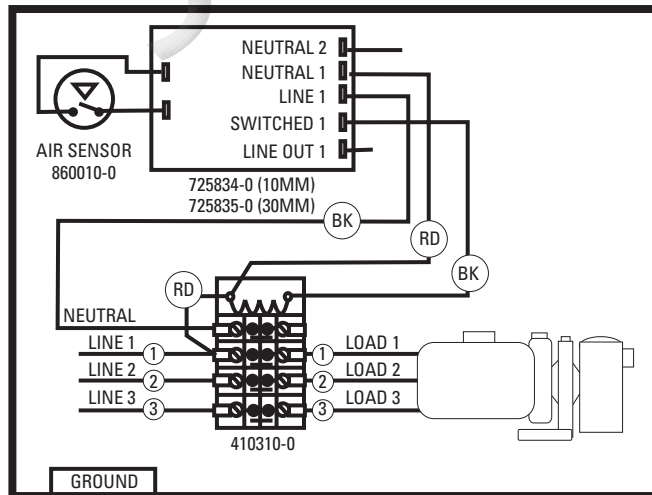

NOTE: GROUND CONNECTIONS ARE NOT SHOWN AND VARY WITH INSTALLATIONS.

## INSTALLING ACCESSORIES

### ACCESSORIES KIT

When unpacking your new HydroPool swim spa, you will find an accessories bag inside containing:

- all necessary o-rings/gaskets
- gate valve stem locks
- filter cover
- coloured light lenses (not required for units ordered with optional L.E.D. lighting)
- tool for opening the wall fitting to access the light bulb
- #10 expansion plug (for skimmer when draining)
- Aquacord swim tether
- chrome decorative lip trim

### CORNER WRAP PILLOW

The corner wrap pillows are pre-installed at the factory and are attached via pin and socket. To remove, grasp ends of pillow and pull away from swim spa seat. To re-install, lineup pins on back of pillow to mounting sockets and press firmly.

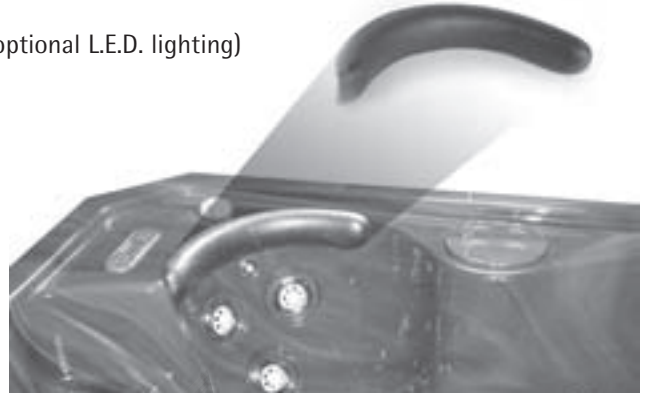

Although the pillows are designed to remain in-place in the swim spa, to extend the life of the pillows, remove after each use.

### AQUACORD TETHER SYSTEM

Should you desire a tether resistance swim or exercise, simply lift the cap of the Aquacord tether anchor and slip one end of the Aquacord onto the anchor and the other around your waste. Adjust the Aquacord length so that your extended arm has at least 46 cm (18 in.) of clearance from the end of the swim spa.

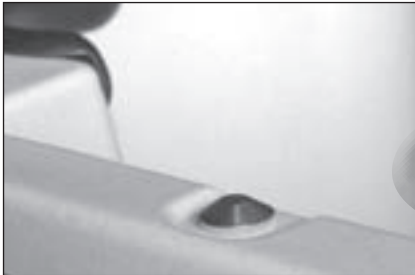

### FILTER COVER

The filter cover provides that finishing touch to your HydroPool swim spa. To install simply place over the filter opening.



## MOOD LIGHTING

### STANDARD MOOD LIGHTING

Press the 'light' pad on the topside control to turn the light on and off.

### LED MOOD LIGHTING OPTIONAL - FACTORY INSTALLED

Press the 'light' pad on the topside control to start the following LED lighting modes. Pressing the 'light' pad on/off within 3 seconds cycles through the various 'light shows'. When the LED lighting is turned off for more than 5 seconds, then turned back on, the system will resume the last 'light show'.

Description of Light Shows:

- Mode 1 – Synchronous colour change
- Mode 2 – Freeze mode, freezes on selected colour blend from above mode (gives unlimited colour blend selection)
- Mode 3 – solid colour blue
- Mode 4 – solid colour green
- Mode 5 – solid colour red
- Mode 6 – solid white (simulated)

### CHANGING BULBS & LENSES

The coloured light lenses supplied with your swim spa (not required for units with optional LED lighting) simply push over the existing clear light lens.



### SAFETY HARDCOVER LOCKS

In an uncovered swim spa, over 90% of the heat is lost from the water surface. Hydropool hard covers are engineered for maximum thermal efficiency and appearance. Simply place the cover on the swim spa, pull the straps down so that they are fully extended, then release slightly so that there is approximately 6 mm (1/4 in.) of slack. Mark the position on the cabinet or deck surface, and fasten the receiver clip with the screws provided. Always ensure the safety hard cover is in place and locked whenever the swim spa is not being used.



### COVER REMOVER – OPTIONAL

A Hydropool cover lifter assists in the removal of the safety hard cover. Please refer to the instructions supplied with your particular cover remover for installation. For further information, contact your local Hydropool dealer.



## FILLING, CHECKING AND STARTING YOUR SWIM SPA

Although your swim spa was thoroughly water-tested in the factory, some loosening of fittings can occur during shipping. Before any decking, tiling or carpeting is completed around the installation, fill and operate your swim spa to test for leaks (this ensures easy access and inexpensive correction). Check all union connections and plumbing for minor leaks. In the event of a leak, ensure all union connections and pump plugs are tight, and all o-rings/gaskets are in place.

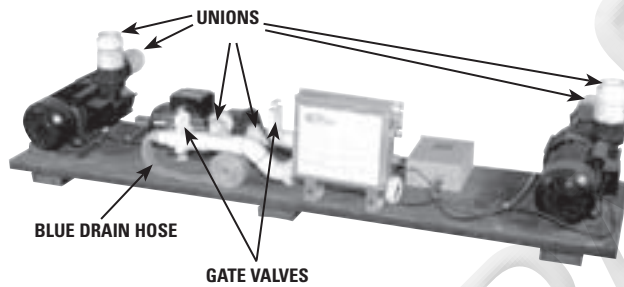
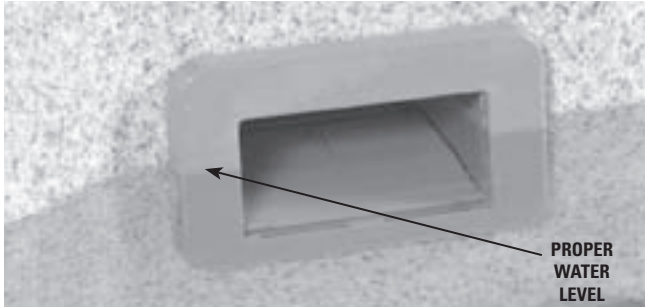

- When adding water for the first time, the swim spa should be filled through the skimmer opening (helps to prevent air locks) using a standard garden hose, turning the tap on slowly to prevent damage to the surface by a jerking hose connection.
- Pull up the handles on the intake and return gate valves and install stem locks (handles are pulled up when valves are open and pushed down when valves are closed).
- Ensure the drain hose gate valve is closed.
- Ensure that all jets are open. See section JET & FEATURE OPERATION – p. 42
- Fill the swim spa to the recommended level, approximately 19 mm (3/4 in.) from the top of the skimmer opening.
- STEEL SUPPORT LEG ADJUSTMENT: While the swim spa is filling, it may be necessary to adjust the steel support legs. Should the unit bow outward, lengthen the steel support leg by turning the top nut counter clockwise. Should the shell bow inward, shorten the steel support leg by turning the top nut clockwise. Be careful to only adjust the nut 1/4 or 1/2 a turn at any one time. Do not extend the leg length too much as this may cause deformation on the top flange. Adjustments may be necessary on more than one leg. For final adjustment see section STEEL SUPPORT LEG ASSEMBLY DETAILS – p. 12
- Visually check all union connections pump plugs and plumbing for minor leaks. In the event of a leak, ensure all union connections and pump plugs are tight and o-rings/gaskets are in place and not pinched.
- Before applying voltage to power-up your swim spa, it is very important that you understand the sequence of events that occur when the system is activated in order that the pump can be primed efficiently and damage to the system can be avoided. See section PUMP PRIMING/RELEASING AN AIR LOCK – p.21
- Turn the main power ON at your electrical panel.
- Follow the control instructions for your particular model swim spa to put the pump into low speed. See section HYDROPOOL SWIM SPA CONTROL SYSTEMS – p. 22

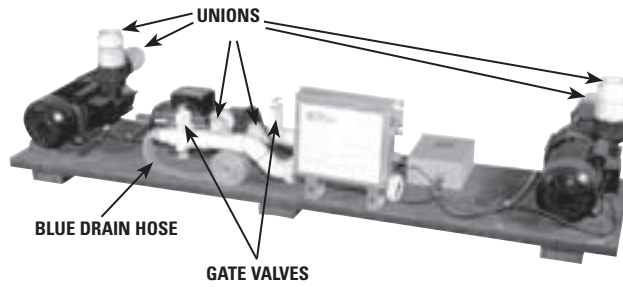

### RELEASING AIR TRAPPED IN FILTER...



### PUMP PRIMING/RELEASING AN AIR LOCK...

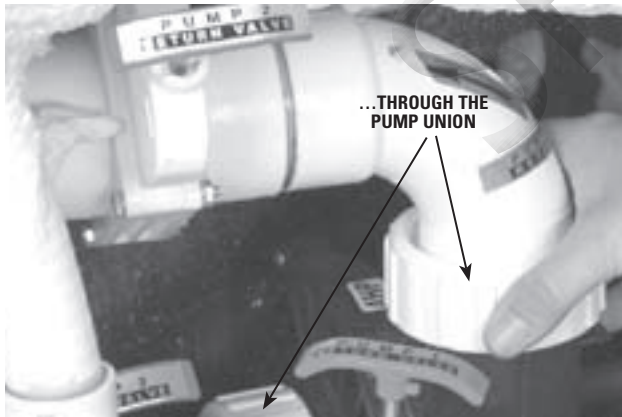

#### PUMP PRIMING/RELEASING AN AIR LOCK

On some systems a *Pr* message will appear on the display indicating that the system is in PUMP PRIMING MODE. This mode will last for 4 to 5 minutes before automatically entering the normal operation mode. See complete details for your swim spa in section HYDROPOOL SWIM SPA CONTROL SYSTEMS - p. 22

- If the pump(s) is located below water level, the water should start circulating immediately. If the motor works but you do not notice water circulation within the first 15 seconds, the pump may require priming due to trapped air (referred to as an 'air lock'). If the pumps have not self-primed after 2 minutes, and water is not flowing from the jets, **DO NOT allow the pumps to continue to run.** Turn power off at the main house panel (or GFCI) and try releasing the air by loosening the union on the discharge side of the pump(s) while the motor is not running. Turn the power back on. If the pumps do not prime after 15 seconds, sometimes momentarily turning the pump(s) off and on will help the system to prime (note: do not do this more than 5 times).

**Important:** Under NO circumstances should the pump(s) be allowed to operate without priming beyond 5 minutes, as this may not only cause unwarrantable damage to the pump, it may also cause the control system to go into an overheat condition.

Definition: 'Priming' a pump is a term used to describe the process in which air trapped in the plumbing and pump wet-end (referred to as an 'air lock') is released, allowing the pump to move water efficiently through the plumbing system and to the jets.



- When the pump starts circulating on low speed, it will be necessary to release trapped air in the filter. Carefully loosen the vent valve counter-clockwise until there is the hissing sound of air escaping. Once there is a steady stream of water, close the vent valve, ensuring that the o-ring does not become pinched.
- If your swim spa is equipped with the optional REMOTE ABOVE-GRADE EQUIPMENT PACKAGE, close the gate valves on either side of the pump(s), loosen off the lids on the priming pots, fill with water, re-install lid(s), turn on the pump(s), and simultaneously re-open gate valve(s).
- Turn the pump(s) onto high speed and re-check for leaks. The control system will automatically return the pump(s) to low speed (or OFF) after 30 minutes.
- Adjust the swim spa heat control at the topside panel to the desired water temperature.
- Adjust water balance (pH, TA, calcium hardness) to recommended levels and add sanitizer. See section SWIM SPA WATER BALANCE - p.44
- The swim spa will initially require 24-48 hours to reach the desired temperature.
- Ensure the insulating bubble cover provided, or the optional insulated safety hard cover, remain on the swim spa and the air controls are closed during the entire heat up process.

# HYDROPOOL SWIM SPA SERIES CONTROL SYSTEMS NORTH AMERICA

## HYDROPOOL AQUATRAINER SERIES





on pump priming.

Once pump priming has been successfully completed, press the  pads to turn off the pumps. Next, manually exit PRIMING MODE by pressing either the  pad or the  pad. If you do not manually exit Priming Mode, it will automatically terminate after 4 to 5 minutes. Be sure that the pumps have been primed before exiting this mode.

### INITIAL START-UP

Before applying voltage to power-up your swim spa, it is very important that you understand the sequence of events that occur when the system is activated in order that the pumps can be primed efficiently and damage to the pumps can be avoided.





 At initial power-up, this display will appear, and the system will show 4 sets of numbers in succession (ie. 100 then 113 then 15 then 240). These numbers represent the current software revision, and the system input voltage.

 After the initial software indicators are shown, this display will appear. This display is indicating that the system is in PUMP PRIMING MODE. This mode will last for 4 to 5 minutes before automatically exiting and entering the normal operation mode. You can also manually exit the PUMP PRIMING MODE after the pumps are primed.

While in this mode, the heater circuit is disabled to allow the priming process to be completed without the possibility of energizing the heater element during low flow or no flow conditions. The system will not automatically activate any of the functions, however, by pushing the  pads on the topside control, the pumps can be manually activated

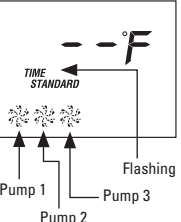

**Definition:** 'Priming' a pump is a term used to describe the process in which air trapped in the plumbing and pump wet-end (referred to as an 'air lock') is released, allowing the pump to move water efficiently through the plumbing system and to the jets.



### PUMP PRIMING MODE

 As soon as 'PR' is indicated on the topside panel, push the left  pad to start Pump 1 in low speed, then again to switch to high speed. Push the center  pad and right  pad to start Pump 2 and Pump 3 respectively. These are both single speed - high only. All of the pumps will now be operating in high speed to facilitate priming. See FILLING, CHECKING AND STARTING YOUR SWIM SPA - p. 20 for complete instructions

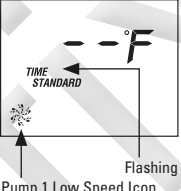
### TEMPERATURE CONTROL FUNCTIONALITY AND ADJUSTMENT

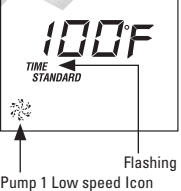

After you manually exit or the system automatically exits PRIMING MODE, your swim spa will automatically heat to the factory preset default temperature of 27°C (80°F). The topside panel will briefly show the default temperature, and then the display will appear as follows:

 Note that the water temperature is not yet displayed, as the system requires approximately 2 minutes of water flow through the heater to determine temperature. This is referred to as 'polling' and is indicated on the display by the  icon. After 2 minutes the display will show the current measured water temperature.

 Press the  pad to increase the temperature to the desired setting. The  icon will appear on the display indicating that the heater has been activated.

The system automatically activates Pump 1 low speed every 30 minutes for at least 2 minutes. After 2 minutes, the water temperature is determined. At this point, if the water temperature is lower than the set temperature, P1 will continue to run and the  icon will appear on the display. The heater will operate until the water temperature reaches the set temperature point, after which, both the heater and Pump 1 low will automatically turn off.

### TO CHECK/CHANGE THE SET TEMPERATURE



  The last measured temperature is constantly displayed on the topside control. When either of these pads is pressed once, the display will show the set temperature. Press either pad a second time to increase or decrease the set temperature. After 3 seconds the display will once again show the last measured temperature.

The temperature can be adjusted from 21°C (70°F) to 40°C (104°F) in 1° increments

### PUMPS / JETS FUNCTION

 from left to right on topside control – P1, P2, P3

#### PUMP 1 (P1)

- 1<sup>st</sup> press – turns on low speed – the P1 icon  spins slowly
- 2<sup>nd</sup> press – turns on high speed – the P1 icon  spins faster
- 3<sup>rd</sup> press – turns off pump – no icon displayed when P1 is off

When P1 low is already operating, the 1<sup>st</sup> press of the P1  pad puts the pump directly into high speed.

Low speed P1 starts automatically every 30 minutes to measure water temperature (in STANDARD Mode only – see MODE FUNCTION), when a filter cycle is activated, or when a freeze condition is detected.

When P2 or P3 is manually activated, P1 low speed is automatically activated and operates until the pump(s) time out. If P2 or P3 is turned on even briefly, and then turned back off, P1 low will operate for a minimum of 2 minutes.

#### PUMP 2 (P2)

- 1<sup>st</sup> press – turns on high speed – the P2 icon  spins fast
- 2<sup>nd</sup> press – turns off pump – no icon displayed when P2 is off.

#### PUMP 3 (P3)

- 1<sup>st</sup> press – turns on high speed – the P3 icon  spins fast
- 2<sup>nd</sup> press – turns off pump – no icon displayed when P3 is off.

### PUMPS AUTOMATIC TIME-OUT



P1 high speed, P2 & P3 – 30 minutes  
 P1 low speed – 4 hours.



### CLEAN-UP CYCLES

The Clean-up Cycle begins 30 minutes after the pump(s) have been turned off or have automatically timed-out. P1 low speed and the ozonator (optional) will operate for one hour.

### SETTING THE SYSTEM CLOCK TIME

The  flashes on the topside control display upon initial start-up. This reminder will disappear once the clock time is programmed.

Press  then  to enter programming mode.

To set the hour: Press  or  - each press changes the time by 1 hour.

Press  to enter, and to continue to set minutes.

To set minutes: Press  or  - each press changes the time by 1 minute.

Press the  pad again to continue to the filter cycle programming mode (see below)

OR

Press the  pad to exit programming mode.

During normal operation, pressing the  pad will display the current time for 3 seconds.

### FILTER CYCLES





Once the system clock time has been programmed, the system will automatically activate P1 low speed to filter the water for 2 hours twice each day.

#### FACTORY PRESET DEFAULT

'FILTER 1' the system automatically activates P1 low to operate from 8 AM to 10 AM. The F1 LED indicator, located on the left side of the topside control panel, will light during filter cycle 1 operation.

'FILTER 2' the system automatically activates P1 low to operate from 8 PM to 10 PM. The F2 LED indicator, located on the left side of the topside control panel, will light during filter cycle 2 operation.

### PROGRAMMING FILTER CYCLES

To change the factory default filter cycle settings Press  then  then  then  within three seconds.

(You will already have advanced to this point if you pressed  after completing the SETTING THE SYSTEM CLOCK TIME programming sequence)

At this point *PROGRAM*, *FILTER1* and *START TIME* will appear on the display



To set the hour: Press  or  - each press changes the time by 1 hour.

Press  to enter, and to continue to set minutes.



To set minutes: Press  or  - each press changes the time by 5 minutes

Press  to enter, and to proceed

At this point *PROGRAM*, *FILTER1* and *END TIME* will appear on the display

To set the hour: Press  or  - each press changes the time by 1 hour.

Press  to enter, and to continue to set minutes

To set minutes: Press  or  - each press changes the time by 5 minutes

Press  to enter, and to proceed

At this point *PROGRAM*, *FILTER 2* and *START TIME* will appear on the display

Adjust time as above

Press  to enter, and to proceed

At this point *PROGRAM*, *FILTER 2* and *END TIME* will appear on the display

Adjust time as above

Press the  pad again to enter the filter cycle times into the system and exit programming mode.





The 'F1' light on the left side of the topside control panel will illuminate to indicate that the system is in Filter 1 cycle.

The 'F2' light on the left side of the topside control panel will illuminate to indicate that the system is in Filter 2 cycle.

### PURGE CYCLES

The system automatically activates P2 & P3 for 5 minutes at the beginning of each filter cycle to circulate fresh, sanitized water into these plumbing circuits.

### MODE FUNCTION

 This pad is used to change swim spa operation to either *STANDARD*, *ECONOMY* or *SLEEP* mode. Press  to enter mode programming and press  to select the desired mode. The LCD will flash until  is pressed again to confirm the selection.



### STANDARD MODE

The system automatically starts P1 low speed every 30 minutes to measure water temperature, and maintain the set temperature. The word *STANDARD* will remain on the display along with the last measured temperature. The current water temperature is displayed only after the pump has been operating for at least 2 minutes.

### ECONOMY MODE

The system will heat to the set temperature only during the filter cycles. The display will show the word *ECONOMY*.

### STANDARD-IN-ECONOMY MODE

While the system is in Economy Mode, pressing any  pad will cause the system to activate Standard Mode for 1 hour, after which the system will revert back to Economy Mode. Pressing the  pad during this time will put the system back into Economy Mode immediately.

### SLEEP MODE

The system will heat to within 10°C (20°F) of the set temperature only during filter cycles. The display will show the word *SLEEP*.

### LIQUID CRYSTAL DISPLAY (LCD)



Continually provides feedback on the operating status of the swim spa. Icons indicate various functions and programming information.

### LCD INVERT

This feature inverts the LCD readout for convenient viewing from inside the swim spa. To invert the readout,

Press  or  then \*

\*Top right hand corner on topside control panel

To return the LCD readout to normal viewing (from outside of the swim spa), repeat.



## TOPSIDE PANEL LOCK FEATURES

### TEMPERATURE LOCK

The temperature lock feature prevents unauthorized water temperature adjustment. When the temperature lock is activated, all automatic functions will continue to operate normally.

The following pads must be pressed within 3 seconds of each other to activate the lock:

 then  then P1  then 

### TEMPERATURE UNLOCK

The following pads must be pressed within 3 seconds of each other to deactivate the lock:

 then  then P1  then 

When locked, the 'TL' light on the left side of the topside control panel will illuminate. Only the topside control panel temperature pads will be deactivated.

### TOPSIDE PANEL FULL LOCK



The topside panel lock feature prevents unauthorized use of the swim spa controls. When the topside control panel lock is activated, all automatic functions will continue to operate normally.

The following pads must be pressed within 3 seconds of each other to activate the lock:

 then P1  then 

### TOPSIDE PANEL UNLOCK

The following pads must be pressed within 3 seconds of each other to deactivate the lock:

 then P1  then 

When locked, the 'PL' light on the left side of the topside control panel will illuminate. All of the topside control panel pads will be deactivated except for the  pad.

## STANDBY / DRAIN ASSIST

The standby/drain assist feature stops the system from operating automatically, allowing for convenient filter cartridge removal and for safe draining of the swim spa. The following pads must be pressed within 3 seconds of each other.

Press  then the P2  pad and the display will flash:  
*SBY*

All functions will turn off, but P1 low speed can be activated (by pressing the P1  pad) to facilitate draining the swim spa and the display will show *drn*

Press any pad other than the P1  pad to return the system to normal operation. See section DRAINING YOUR SWIM SPA– p. 49 – for detailed instructions.



## MOOD LIGHTING



### STANDARD MOOD LIGHTING

Press the  pad on the topside control to turn the light on and off.

### LED MOOD LIGHTING OPTIONAL – FACTORY INSTALLED

Press the  pad on the topside control to start the selection of LED lighting modes. Pressing the  pad on/off within 3 seconds cycles through the various 'light shows'. When the LED lighting is turned OFF for more than 5 seconds, then turned back ON, the system will resume the last 'light show'. For complete description of 'light shows', see MOOD LIGHTING – p. 19

The system will automatically turn off the mood lighting after 4 hours.

### OZONATOR OPTIONAL

The ozonator operates during FILTER CYCLES and CLEAN UP CYCLES only. The display will show the *03* icon while the ozonator is operating.

### FREEZE PROTECTION

If the temperature sensor detects a drop to 4°C (39°F) within the heater chamber, the system automatically activates the pumps to provide freeze protection. The pumps will operate until the temperature reaches 5°C (41°F) before returning to normal system mode.

# HYDROPOOL SWIM SPA SERIES CONTROL SYSTEMS NORTH AMERICA

## HYDROPOOL AQUATRAINER SERIES\*

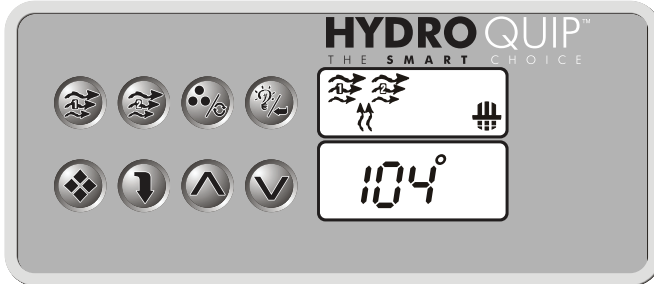

### INITIAL START-UP

When you initially power up your swim spa, it will default to the factory-preset temperature of 35°C (95°F), and a filtration cycle of 1 out of every 12 hours (see FILTER CYCLES)

### TEMPERATURE ADJUSTMENT



Use these arrows to increase or decrease water temperature. The temperature setting will be displayed for 5 seconds to confirm your new selection.

**NOTE:** The set point symbol indicates the desired temperature, NOT the current water temperature!

Water temperature can be adjusted by 1° increments from 15°C - 40°C (59°F - 104°F)

### PUMPS/JETS FUNCTION



#### PUMP 1 (P1):

- 1st press - turns on low speed of pump
- 2nd press - turns on high speed of pump
- 3rd press - turns off high speed of pump



#### PUMP 2 (P2) / PUMP 3 (P3):

- 1st press - turns on P2
- 2nd press - turns on P3
- 3rd press - turns off P2
- 4th Press - turns off P3

When P1 low is already operating, the 1st press of the P1 pad puts the pump directly into high speed.

### PUMPS AUTOMATIC TIME-OUT

P1, P2 and P3 - 20 minutes

### FILTER CYCLES

Your swim spa control system automatically activates P1 low speed to filter the water twice each day (one filter cycle every 12 hours). The first filter cycle begins 1 minute after your spa is initially powered up. The second filter cycle will begin 12 hours after the start of the first filter cycle. The duration of the filter cycle (length of time P1 low runs) is programmable from the topside control panel, and can be set from 0 -12 hours, where 0 represents no filtration and 12 represents continuous filtration.

Example: selecting 3 would configure the system for 3 hours of filtration every 12 hours (3 hrs on, 9hrs off).

The low speed pump will start automatically when:

- the system calls for heat. The Heater indicator  lights when the heater is on, and flashes when the system is calling for heat, but the heater has not yet activated.
- a filter cycle is activated.
- a freeze condition is detected. See FREEZE PROTECTION/SMART WINTER MODE

When low speed is already on, the 1st press of the  pad puts the pump directly into high speed.

### SYSTEM PROGRAMMING



Enter Programming mode by pressing down and holding the PROGRAM pad for 5 seconds, then proceed through the following steps:

#### SYSTEM CLOCK TIME:

The hour will be flashing on the display



Press the ENTER/LIGHT pad



Use the UP and DOWN arrows to adjust the hour from 00: to 11:



Press the PROGRAM pad  followed by the ENTER/LIGHT pad  and the minutes will flash on the display

Use the UP and DOWN arrows to adjust the minutes from 00: to 59:

Press the PROGRAM pad  to confirm setting and advance to the next parameter

\* OPTIONAL REMOTE ABOVE-GRADE EQUIPMENT PACKAGE – NORTH AMERICA ONLY

## FILTER CYCLE START TIME AND DURATION

The system automatically performs two filter cycles per day. To program a filter cycle, you must enter 1) the time you want the filter cycle to start and 2) the duration of the filter cycle.

### SETTING FIRST FILTER CYCLE START TIME:

'Fon1' will be showing on the display

 Press the ENTER/LIGHT pad

  Use the UP and DOWN arrows to adjust the hour from 00 to 11

Press the PROGRAM pad  followed by the ENTER/LIGHT pad  and the minutes will flash on the display

Use the UP and DOWN arrows to adjust the minutes from 00 to 59

Press the PROGRAM pad  to confirm setting and advance to the next parameter

### SETTING FIRST FILTER CYCLE DURATION:

'Fdu1' will be showing on the display

 Press the ENTER/LIGHT pad

  Use the UP and DOWN arrows to adjust from OFF (always off) to 12 (always on)

Press the PROGRAM pad  to confirm setting and advance to the next parameter

### SETTING SECOND FILTER CYCLE START TIME:

'Fon2' will be showing on the display

 Press the ENTER/LIGHT pad

  Use the UP and DOWN arrows to adjust the hour from 00 to 11

Press the PROGRAM pad  followed by the ENTER/LIGHT pad  and the minutes will flash on the display

Use the UP and DOWN arrows to adjust the minutes from 00 to 59

Press the PROGRAM pad  to confirm setting and advance to the next parameter

### SETTING SECOND FILTER CYCLE DURATION:

'Fdu2' will be showing on the display

 Press the ENTER/LIGHT pad

  Use the UP and DOWN arrows to adjust from OFF (always off) to 12 (always on)

Press the PROGRAM pad  to confirm setting and advance to the next parameter

To prevent excessive water temperature due to long filtration cycles during warmer weather (referred to as 'thermal creep'):

If the water temperature exceeds the set point by more than 2°F for more than 3 hours, the system will turn off the pump. The 'Filter' indicator  will flash on/off for the rest of the duration of the filter cycle – on for .5 seconds, off for .5 seconds, on for .5 seconds, off for 1.5 seconds. Should the water temperature cool down to 1°F above the set point before the filter cycle times out, the system will activate the pump for the remaining duration of the cycle.

## ECONOMY START TIME AND DURATION:

Economy mode maintains water temperature at 10°C (20°F) below the set point temperature. See MODE FUNCTION for complete details.

Anytime the system is in Economy mode, this icon  will show on the display.

### SETTING FIRST ECONOMY CYCLE START TIME:

'Eon1' will be showing on the display

 Press the ENTER/LIGHT pad

  Use the UP and DOWN arrows to adjust the hour from 00 to 11

Press the PROGRAM pad  followed by the ENTER/LIGHT pad  and the minutes will flash on the display

Use the UP and DOWN arrows to adjust the minutes from 00 to 59

Press the PROGRAM pad  to confirm setting and advance to the next parameter

### SETTING FIRST ECONOMY CYCLE DURATION:

'Edu1' will be showing on the display

 Press the ENTER/LIGHT pad

  Use the UP and DOWN arrows to adjust from OFF (always off) to 24 (always on)

Press the PROGRAM pad  to confirm setting and advance to the next parameter

### SETTING SECOND ECONOMY CYCLE START TIME:

'Eon2' will be showing on the display

 Press the ENTER/LIGHT pad

  Use the UP and DOWN arrows to adjust the hour from 00 to 11

Press the PROGRAM pad  followed by the ENTER/LIGHT pad  and the minutes will flash on the display

Use the UP and DOWN arrows to adjust the minutes from 00 to 59

Press the PROGRAM pad  to confirm setting and advance to the next parameter

#### SETTING SECOND ECONOMY CYCLE DURATION:

'Edu2' will be showing on the display

 Press the ENTER/LIGHT pad

  Use the UP and DOWN arrows to adjust from OFF (always off) to 24 (always on)

Press the PROGRAM pad  to confirm setting and advance to the next parameter

#### SETTING THIRD ECONOMY CYCLE START TIME:

'Eon3' will be showing on the display

 Press the ENTER/LIGHT pad

  Use the UP and DOWN arrows to adjust the hour from 00 to 11

Press the PROGRAM pad  followed by the ENTER/LIGHT pad  and the minutes will flash on the display

Use the UP and DOWN arrows to adjust the minutes from 00 to 59

Press the PROGRAM pad  to confirm setting and advance to the next parameter

#### SETTING THIRD ECONOMY CYCLE DURATION:

'Edu3' will be showing on the display

 Press the ENTER/LIGHT pad

  Use the UP and DOWN arrows to adjust from OFF (always off) to 24 (always on)

Press the PROGRAM pad  to confirm setting and advance to the next parameter

#### PURGE CYCLES

The system automatically activates P2 & P3 for 1 minute at the beginning of each filter cycle to circulate fresh, sanitized water into these plumbing circuits.

#### MODE FUNCTION

 This pad is used to change swim spa operation from STANDARD to ECONOMY mode.

#### ECONOMY MODE:

Maintains water temperature at 10°C (20°F) below the set point temperature. When Economy mode is manually activated by pressing the ECONOMY pad, user programming is overridden until midnight of the current day, or until manually deactivated.

#### STANDARD MODE:

The user set point temperature is maintained. The system automatically activates P1 low speed whenever there is a heat demand.

#### LIQUID CRYSTAL DISPLAY (LCD)

 Continually provides feedback on the operating status of the swim spa. Icons indicate various functions and programming information.

#### INVERTING THE DISPLAY:

This feature inverts the LCD readout for convenient viewing from inside the swim spa. Press and hold the ECONOMY pad  for 2 seconds to toggle between inverted and normal display modes.

#### TOPSIDE PANEL LOCK FEATURE

The topside panel lock feature prevents unauthorized use of the controls. While the panel lock feature is enabled, all automatic system functions will continue to operate normally.

#### TO LOCK

Press and hold the P1 pad  for 5 seconds. The display will show 'LocF'

#### TO UNLOCK

Press and hold the P1 pad  again for 5 seconds until the display shows 'Uloc'

## MOOD LIGHTING

### STANDARD MOOD LIGHTING

Press the LIGHT/ENTER pad  on the topside control panel to operate the light as follows:

- 1st press – highest light intensity
- 2nd press – medium light intensity
- 3rd press – low light intensity
- 4th press – OFF

### LED MOOD LIGHTING OPTIONAL – FACTORY INSTALLED

Press the LIGHT/ENTER pad  on the topside control panel to start the selection of LED lighting modes. Pressing the pad ON/OFF within 3 seconds cycles through the various 'light shows'. When the LED lighting is turned OFF for longer than 5 seconds, then turned back ON, the system will resume the last 'light show'. For complete detailed description of 'light shows' see MOOD LIGHTING – p.19

## OZONATOR OPTIONAL

The ozonator operates during FILTER CYCLES only.

## FREEZE PROTECTION / SMART WINTER MODE

The system continuously monitors the ambient air temperature inside the control box. If at anytime the temperature drops below 13°C (55°F) the system activates the Freeze/Winter Mode for the next 24 hours. In this mode, if the pump has not operated during the last 2 hours (whether manually or automatically), P1 low speed will automatically activate for 1 minute to circulate warm water through the plumbing. While the pump is operating in this mode, the Filter mode indicator  will flash on the display.

SPAFIX

# HYDROPOOL SWIM SPA SERIES CONTROL SYSTEMS NORTH AMERICA

## HYDROPOOL AQUAPLAY SERIES

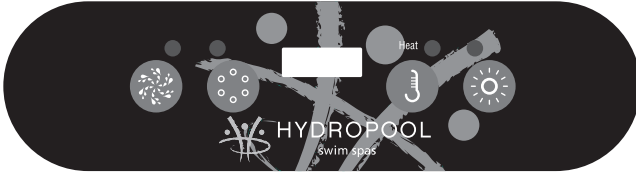

### INITIAL START-UP

Before applying voltage to power-up your swim spa, it is very important that you understand the sequence of events that occur when the system is activated in order that the pump can be primed efficiently and damage to the system can be avoided.

**005** At initial power-up, this display will appear, and the system will show 4 sets of numbers in succession (ie. 100 then 103 then 15 then 240). These numbers represent the current software revision, and the system input voltage.

**Pr** After the initial software indicators are shown, this display will appear. This display is indicating that the system is in **PUMP PRIMING MODE**. This mode will last for 4 to 5 minutes before automatically exiting and entering the normal operation mode. You can also manually exit PUMP PRIMING MODE after the pump is primed.

While in this mode, the heater circuit is disabled to allow the priming process to be completed without the possibility of energizing the heater element during low flow or no flow conditions. The system will not automatically activate any of the functions, however, by pushing the  pad on the topside control, the pump can be manually activated.

**Definition:** 'Priming' a pump is a term used to describe the process in which air trapped in the plumbing and pump wet-end (referred to as an 'air lock') is released, allowing the pump to move water efficiently through the plumbing system and to the jets.

### PUMP PRIMING MODE

**Pr** As soon as 'PR' is indicated on the topside panel, push the  pad to start Pump 1 in low speed, then again to switch to high speed to facilitate priming. See FILLING, CHECKING AND STARTING YOUR SWIM SPA - p. 20 for complete instructions on pump priming.

Once pump priming has been successfully completed, press the  pad to turn off the pump.

Next, manually exit PRIMING MODE by pressing the  pad. If you do not manually exit PRIMING MODE, it will automatically terminate after 4 to 5 minutes. Be sure that the pump is primed before exiting this mode.

### TEMPERATURE CONTROL FUNCTIONALITY AND ADJUSTMENT



After you manually exit or the system automatically exits PRIMING MODE, your swim spa will automatically heat to the factory preset default temperature of 38°C (100°F) The topside panel will briefly show the default temperature, and then the display will appear as follows:

 Note that the water temperature is not yet displayed, as the system requires approximately 2 minutes of water flow through the heater to determine temperature. This is referred to as 'polling' and is indicated on the display by the -- icon. After 2 minutes the display will show the current measured water temperature

**102** Press the  pad to increase the temperature to the desired setting. The Heat indicator light on the topside control panel will shimmer for 90 seconds, indicating that the system is not yet heating, then will illuminate solidly to indicate that the heater circuit has been energized and the water is being heated.

The system automatically activates Pump 1 low speed every 30 minutes for at least 2 minutes. After 2 minutes, the water temperature is determined. At this point, if the water temperature is lower than the set temperature, P1 will continue to run and the Heat indicator light on the topside control panel will illuminate. The heater will operate until the water temperature reaches the set temperature point, after which, both the heater and Pump 1 low will automatically turn off.

### TO CHECK/CHANGE THE SET TEMPERATURE

 The last measured temperature is constantly displayed on the topside panel. When this pad is pressed once any time during normal operation, the display will show the set temperature for 3 seconds. Press this pad a second time to increase or decrease the set temperature. To change the direction of the temperature settings (ie. lower vs. raise the temperature), allow the display to revert back to the current water temperature then press the  pad again.

The temperature can be adjusted from 21°C (70°F) to 40°C (104°F) in 1° increments.

## PUMP / JETS FUNCTION

 Press this pad to activate the pump

- 1st press – turns on low speed
- 2nd press – turns on high speed
- 3rd press – turns off pump

When low speed is already operating, the 1st press of the  pad puts the pump directly into high speed.

Low speed starts automatically every 30 minutes to measure water temperature (in STANDARD Mode only – see MODE FUNCTION), when a filter cycle is activated, or when a freeze condition is detected.

## PUMP AUTOMATIC TIME-OUT

- High speed – 15 minutes
- Low speed – 2 hours

## CLEAN-UP CYCLES



The Clean-up Cycle begins 30 minutes after the pump has been turned off or has automatically timed-out. The pump low speed and the ozonator (optional) will operate for one hour.

## FILTER CYCLES

The system will automatically activate the pump low speed to filter the water either once or twice each day, and can be programmed by the user. The first filter cycle ("day") begins 6 minutes after the spa is initially powered up. The second filter cycle ("night") begins 12 hours after the start of the first filter cycle. The filter cycle duration – length of time the pump low runs – is programmable from 1 to 12 hours (F1 to F12). The factory default is 2 hours, twice daily.



## PROGRAMMING FILTER CYCLES

To change the factory default filter cycle settings

Press  then  – the current filter cycle duration will be displayed

Press  to configure the filter cycle frequency

The display will show:

-  both day and night cycles
-  day cycle only
-  night cycle only

Press  to select the number of filter cycles



For continuous filtration, select F12 and 

Press  to exit programming mode and save changes.

## MODE FUNCTION

A combination of keypads is used to change swim spa operation to either 'STANDARD', 'ECONOMY' or 'SLEEP' mode.

## PROGRAMMING MODE FUNCTION

Press  then  – the current mode setting will flash on the display

Press  to cycle through to the desired mode

Press  to select and confirm the selection.





## STANDARD MODE

The system automatically starts the pump low speed every 30 minutes to measure water temperature, and maintain the set temperature. The display will show *SEd* briefly, then the last measured water temperature. The current water temperature is displayed only after the pump has been operating for at least 2 minutes.

## ECONOMY MODE

The system will heat to the set temperature only during the filter cycles. The display will show *Ee* when the temperature is non-current. When the temperature is current, the display will alternate between *Ee* and the water temperature.

### STANDARD-IN-ECONOMY MODE



While the system is in Economy Mode, pressing the  pad or the  pad will cause the system to activate Standard Mode for 1 hour, after which the system will revert back to Economy Mode. The display will show *Std* while in this mode. Pressing the  then  pads during this time will put the system back into Economy Mode immediately.

### SLEEP MODE

The system will heat to within 10°C (20°F) of the set temperature only during filter cycles. The display will show *SLP* until the mode is changed.

### STANDBY / DRAIN ASSIST

The standby/drain assist feature stops the system from operating automatically, allowing for convenient filter cartridge removal and for safe draining of the swim spa. The following pads must be pressed within 3 seconds of each other.

Press  then the  pad - the display will flash *SBY*.

All functions will turn off, but the pump low speed can be activated (by pressing the  pad) to facilitate draining the hot tub - the display will show *DRN*.

Press any pad other than the  pad to return the system to normal operation.

See DRAINING YOUR SWIM SPA - p. 49 - for detailed instructions.



### MOOD LIGHTING



#### STANDARD MOOD LIGHTING

Press the  pad on the topside control to turn the light on and off.

#### LED MOOD LIGHTING OPTIONAL - FACTORY INSTALLED

Press the  pad on the topside control to start the selection of LED lighting modes. Pressing the  pad on/off within 3 seconds cycles through the various 'light shows'. When the LED lighting is turned OFF for more than 5 seconds, then turned back ON, the system will resume the last 'light show'. For complete description of 'light shows', see MOOD LIGHTING - p. 19

The system will automatically turn off the mood lighting after 4 hours.

#### OZONATOR OPTIONAL

The ozonator operates during FILTER CYCLES and CLEAN UP CYCLES only

#### FREEZE PROTECTION

If the temperature sensor detects a drop to 4°C (39°F) within the heater chamber, the system automatically activates the pump to provide freeze protection. The pump will operate until the temperature reaches 5°C (41°F) before returning to normal system mode.





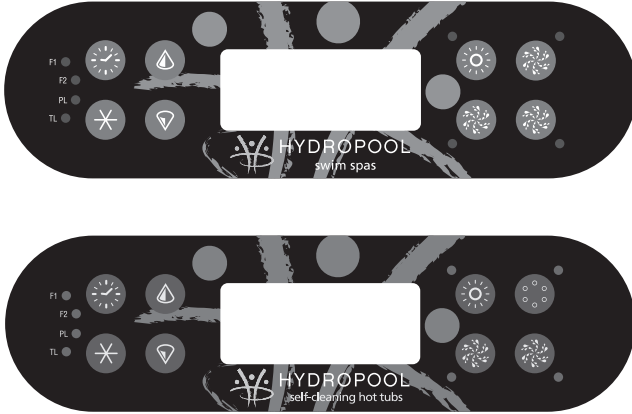

# HYDROPOOL SWIM SPA SERIES CONTROL SYSTEMS EUROPE

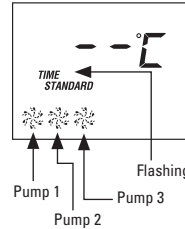

## HYDROPOOL AQUATRAINER & AQUASPORT SERIES



### PUMP PRIMING MODE





As soon as 'PR' is indicated on the topside panel, push the left  pad to start Pump 1 in low speed, then again to switch to high speed. Push the center  pad and right  pad to start Pump 2 and Pump 3 respectively. These are both single speed - high only. All of the pumps will now be operating in high speed to facilitate priming. See FILLING, CHECKING AND STARTING YOUR SWIM SPA- p. 20 for complete instructions on pump priming.

Once pump priming has been successfully completed, press the  pads to turn off the pumps. Next, manually exit PRIMING MODE by pressing either the  pad or the  pad. If you do not manually exit Priming Mode, it will automatically terminate after 4 to 5 minutes. Be sure that the pumps have been primed before exiting this mode.

### INITIAL START-UP

Before applying voltage to power-up your swim spa, it is very important that you understand the sequence of events that occur when the system is activated in order that the pumps can be primed efficiently and damage to the pumps can be avoided.

 At initial power-up, this display will appear, and the system will show 4 sets of numbers in succession (ie. 100 then 113 then 15 then 240). These numbers represent the current software revision, and the system input voltage.

 After the initial software indicators are shown, this display will appear. This display is indicating that the system is in **PUMP PRIMING MODE**. This mode will last for 4 to 5 minutes before automatically exiting and entering the normal operation mode. You can also manually exit the PUMP PRIMING MODE after the pumps are primed.

While in this mode, the heater circuit is disabled to allow the priming process to be completed without the possibility of energizing the heater element during low flow or no flow conditions. The system will not automatically activate any of the functions, however, by pushing the  pads on the topside control, the pumps can be manually activated

**Definition:** 'Priming' a pump is a term used to describe the process in which air trapped in the plumbing and pump wet-end (referred to as an 'air lock') is released, allowing the pump to move water efficiently through the plumbing system and to the jets.

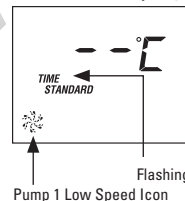

### TEMPERATURE CONTROL FUNCTIONALITY AND ADJUSTMENT

After you manually exit or the system automatically exits PRIMING MODE, your swim spa will automatically heat to the factory preset default temperature of 38°C (100°F). The topside panel will briefly show the default temperature, and then the display will appear as follows:



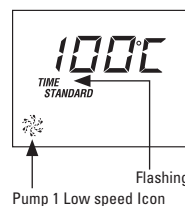

Note that the water temperature is not yet displayed, as the system requires approximately 2 minutes of water flow through the heater to determine temperature. This is referred to as 'polling' and is indicated on the display by the  icon. After 2 minutes the display will show the current measured water temperature.



Press the  pad to increase the temperature to the desired setting. The  icon will appear on the display indicating that the heater has been activated.

The system automatically activates Pump 1 low speed every 30 minutes for at least 2 minutes. After 2 minutes, the water temperature is determined. At this point, if the water temperature is lower than the set temperature, P1 will continue to run and the  icon will appear on the display. The heater will operate until the water temperature reaches the set temperature point, after which, both the heater and Pump 1 low will automatically turn off.

### TO CHECK/CHANGE THE SET TEMPERATURE

  The last measured temperature is constantly displayed on the topside control. When either of these pads is pressed once, the display will show the set temperature. Press either pad a second time to increase or decrease the set temperature. After 3 seconds the display will once again show the last measured temperature.

The temperature can be adjusted from 21°C (70°F) to 40°C (104°F) in 1° increments



### IMPORTANT NOTE

Heater works only on pump 1 low speed and turns off whenever another pump is activated (exception: 3-Phase installations)

### PUMPS / JETS FUNCTION

 from left to right on topside control – P1, P2, P3

#### PUMP 1 (P1)

- 1<sup>st</sup> press – turns on low speed – the P1 icon  spins slowly
- 2<sup>nd</sup> press – turns on high speed – the P1 icon  spins faster
- 3<sup>rd</sup> press – turns off pump – no icon displayed when P1 is off

When P1 low is already operating, the 1<sup>st</sup> press of the P1  pad puts the pump directly into high speed.

Low speed P1 starts automatically every 30 minutes to measure water temperature (in STANDARD Mode only – see MODE FUNCTION), when a filter cycle is activated, or when a freeze condition is detected.

When P2 or P3 is manually activated, P1 low speed is automatically activated and operates until the pump(s) time out. If P2 or P3 is turned on even briefly, and then turned back off, P1 low will operate for a minimum of 2 minutes.

#### PUMP 2 (P2)\*

- 1<sup>st</sup> press – turns on high speed – the P2 icon  spins fast
- 2<sup>nd</sup> press – turns off pump – no icon displayed when P2 is off.

#### PUMP 3 (P3)\*

- 1<sup>st</sup> press – turns on high speed – the P3 icon  spins fast
- 2<sup>nd</sup> press – turns off pump – no icon displayed when P3 is off.

\*For applications requiring a separate dedicated control for P2 and P3, see section SWIM JETS PUMP(S) TIMERS – p. 17

### PUMPS AUTOMATIC TIME-OUT



P1 high speed, P2 & P3 – 30 minutes  
 P1 low speed – 2 hours.

### CLEAN-UP CYCLES

The Clean-up Cycle begins 30 minutes after the pump(s) have been turned off or have automatically timed-out. P1 low speed and the ozonator (optional) will operate for one hour.

### SETTING THE SYSTEM CLOCK TIME

The  flashes on the topside control display upon initial start-up. This reminder will disappear once the clock time is programmed.

Press  then  to enter programming mode.

To set the hour: Press  or  – each press changes the time by 1 hour.

Press  to enter, and to continue to set minutes.

To set minutes: Press  or  – each press changes the time by 1 minute.

Press the  pad again to continue to the filter cycle programming mode (see below)

OR

Press the  pad to exit programming mode.

During normal operation, pressing the  pad will display the current time for 3 seconds.

### FILTER CYCLES





Once the system clock time has been programmed, the system will automatically activate P1 low speed to filter the water for 2 hours twice each day.

#### FACTORY PRESET DEFAULT

'FILTER 1' the system automatically activates P1 low to operate from 8 AM to 10 AM. The F1 LED indicator, located on the left side of the topside control panel, will light during filter cycle 1 operation.

'FILTER 2' the system automatically activates P1 low to operate from 8 PM to 10 PM. The F2 LED indicator, located on the left side of the topside control panel, will light during filter cycle 2 operation.

### PROGRAMMING FILTER CYCLES

To change the factory default filter cycle settings Press  then  then  then  within three seconds.

(You will already have advanced to this point if you pressed  after completing the SETTING THE SYSTEM CLOCK TIME sequence)

At this point *PROGRAM, FILTER1* and *START TIME* will appear on the display

To set the hour: Press  or  - each press changes the time by 1 hour.

Press  to enter, and to continue to set minutes.



To set minutes: Press  or  - each press changes the time by 5 minutes

Press  to enter, and to proceed

At this point *PROGRAM, FILTER1* and *END TIME* will appear on the display

To set the hour: Press  or  - each press changes the time by 1 hour.

Press  to enter, and to continue to set minutes

To set minutes: Press  or  - each press changes the time by 5 minutes

Press  to enter, and to proceed

At this point *PROGRAM, FILTER 2* and *START TIME* will appear on the display

Adjust time as above

Press  to enter, and to proceed

At this point *PROGRAM, FILTER 2* and *END TIME* will appear on the display

Adjust time as above

Press the  pad again to enter the filter cycle times into the system and exit programming mode.

The 'F1' light on the left side of the topside control panel will illuminate to indicate that the system is in Filter 1 cycle.



The 'F2' light on the left side of the topside control panel will illuminate to indicate that the system is in Filter 2 cycle.

### PURGE CYCLES\*

The system automatically activates P2 & P3 for 5 minutes at the beginning of each filter cycle to introduce fresh, sanitized water into these plumbing circuits.

\*For applications requiring a separate dedicated control for P2 and P3, see section SWIM JETS PUMP(S) TIMERS - p. 17

### MODE FUNCTION

 This pad is used to change swim spa operation to either *STANDARD*, *ECONOMY* or *SLEEP* mode. Press  to enter mode programming and press  to select the desired mode. The LCD will flash until  is pressed again to confirm the selection.



### STANDARD MODE

The system automatically starts P1 low speed every 30 minutes to measure water temperature, and maintain the set temperature. The word *STANDARD* will remain on the display along with the last measured temperature. The current water temperature is displayed only after the pump has been operating for at least 2 minutes.

### ECONOMY MODE

The system will heat to the set temperature only during the filter cycles. The display will show the word *ECONOMY*.

### STANDARD-IN-ECONOMY MODE

While the system is in Economy Mode, pressing any  pad or the  pad will cause the system to activate Standard Mode for 1 hour, after which the system will revert back to Economy Mode. Pressing the  pad during this time will put the system back into Economy Mode immediately.

### SLEEP MODE

The system will heat to within 10°C (20°F) of the set temperature only during filter cycles. The display will show the word *SLEEP*.

### LIQUID CRYSTAL DISPLAY (LCD)

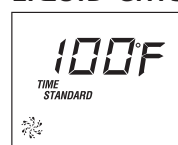

Continually provides feedback on the operating status of the swim spa. Icons indicate various functions and programming information.

### LCD INVERT

This feature inverts the LCD readout for convenient viewing from inside the swim spa. To invert the readout,

Press  or  then \*

\*Top right hand corner on topside control panel

To return the LCD readout to normal viewing (from outside of the swim spa), repeat.

## TOPSIDE PANEL LOCK FEATURES

### TEMPERATURE LOCK

The temperature lock feature prevents unauthorized water temperature adjustment. When the temperature lock is activated, all automatic functions will continue to operate normally.

The following pads must be pressed within 3 seconds of each other to activate the lock:

 then  then P1  then 

### TEMPERATURE UNLOCK

The following pads must be pressed within 3 seconds of each other to deactivate the lock:



 then  then P1  then 

When locked, the 'TL' light on the left side of the topside control panel will illuminate. Only the topside control panel temperature pads will be deactivated.

### TOPSIDE PANEL FULL LOCK

The topside panel lock feature prevents unauthorized use of the swim spa controls. When the topside control panel lock is activated, all automatic functions will continue to operate normally.

The following pads must be pressed within 3 seconds of each other to activate the lock:

 then P1  then 

### TOPSIDE PANEL UNLOCK

The following pads must be pressed within 3 seconds of each other to deactivate the lock:

 then P1  then 

When locked, the 'PL' light on the left side of the topside control panel will illuminate. All of the topside control panel pads will be deactivated except for the  pad.

## STANDBY / DRAIN ASSIST

The standby/drain assist feature stops the system from operating automatically, allowing for convenient filter cartridge removal and for safe draining of the swim spa. The following pads must be pressed within 3 seconds of each other.

Press  then the P2  pad and the display will flash: *SBY*

All functions will turn off, but P1 low speed can be activated (by pressing the P1  pad) to facilitate draining the swim spa and the display will show *drn*

Press any pad other than the P1  pad to return the system to normal operation. See section DRAINING YOUR SWIM SPA – p. 49 – for detailed instructions.



## MOOD LIGHTING



### STANDARD MOOD LIGHTING

Press the  pad on the topside control to turn the light on and off.

### LED MOOD LIGHTING OPTIONAL – FACTORY INSTALLED

Press the  pad on the topside control to start the selection of LED lighting modes. Pressing the  pad on/off within 3 seconds cycles through the various 'light shows'. When the LED lighting is turned OFF for more than 5 seconds, then turned back ON, the system will resume the last 'light show'. For complete description of 'light shows', see MOOD LIGHTING – p. 19

The system will automatically turn off the mood lighting after 4 hours.

### OZONATOR OPTIONAL

The ozonator operates during FILTER CYCLES and CLEAN UP CYCLES only. The display will show the  icon while the ozonator is operating.

### FREEZE PROTECTION

If the temperature sensor detects a drop to 4°C (39°F) within the heater chamber, the system automatically activates the pumps to provide freeze protection. The pumps will operate until the temperature reaches 5°C (41°F) before returning to normal system mode.

# HYDROPOOL SWIM SPA SERIES CONTROL SYSTEMS EUROPE

## HYDROPOOL AQUAPLAY SERIES

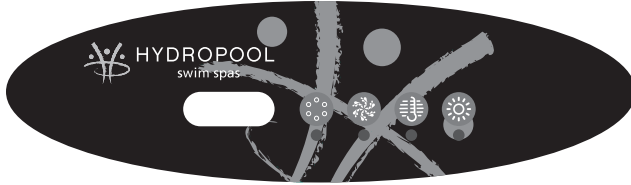

### INITIAL START-UP

Before applying voltage to power-up your swim spa, it is very important that you understand the sequence of events that occur when the system is activated in order that the pump can be primed efficiently and damage to the system can be avoided.

**005** At initial power-up, this display will appear, and the system will show 4 sets of numbers in succession (ie. 100 then 103 then 15 then 240). These numbers represent the current software revision, and the system input voltage.

**Pr** After the initial software indicators are shown, this display will appear. This display is indicating that the system is in **PUMP PRIMING MODE**. This mode will last for 4 to 5 minutes before automatically exiting and entering the normal operation mode. You can also manually exit PUMP PRIMING MODE after the pump is primed.

While in this mode, the heater circuit is disabled to allow the priming process to be completed without the possibility of energizing the heater element during low flow or no flow conditions. The system will not automatically activate any of the functions, however, by pushing the  pad on the topside control, the pump can be manually activated.

**Definition:** 'Priming' a pump is a term used to describe the process in which air trapped in the plumbing and pump wet-end (referred to as an 'air lock') is released, allowing the pump to move water efficiently through the plumbing system and to the jets.

### PUMP PRIMING MODE

**Pr** As soon as 'PR' is indicated on the topside panel, push the  pad to start Pump 1 in low speed, then again to switch to high speed to facilitate priming. See FILLING, CHECKING AND STARTING YOUR SWIM SPA- p. 20 for complete instructions on pump priming.

Once pump priming has been successfully completed, press the  pad to turn off the pump.

Next, manually exit PRIMING MODE by pressing the  pad. If you do not manually exit PRIMING MODE, it will automatically terminate after 4 to 5 minutes. Be sure that the pump is primed before exiting this mode.

### TEMPERATURE CONTROL FUNCTIONALITY AND ADJUSTMENT



After you manually exit or the system automatically exits PRIMING MODE, your swim spa will automatically heat to the factory preset default temperature of 38°C (100°F) The topside panel will briefly show the default temperature, and then the display will appear as follows:

**--** Note that the water temperature is not yet displayed, as the system requires approximately 2 minutes of water flow through the heater to determine temperature. This is referred to as 'polling' and is indicated on the display by the -- icon. After 2 minutes the display will show the current measured water temperature

**102** Press the  pad to increase the temperature to the desired setting. The Heat indicator light on the topside control panel will shimmer for 90 seconds, indicating that the system is not yet heating, then will illuminate solidly to indicate that the heater circuit has been energized and the water is being heated.

The system automatically activates Pump 1 low speed every 30 minutes for at least 2 minutes. After 2 minutes, the water temperature is determined. At this point, if the water temperature is lower than the set temperature, P1 will continue to run and the Heat indicator light on the topside control panel will illuminate. The heater will operate until the water temperature reaches the set temperature point, after which, both the heater and Pump 1 low will automatically turn off.

### TO CHECK/CHANGE THE SET TEMPERATURE

 The last measured temperature is constantly displayed on the topside panel. When this pad is pressed once any time during normal operation, the display will show the set temperature for 3 seconds. Press this pad a second time to increase or decrease the set temperature. To change the direction of the temperature settings (ie. lower vs. raise the temperature), allow the display to revert back to the current water temperature then press the  pad again.

The temperature can be adjusted from 21°C (70°F) to 40°C (104°F) in 1° increments.

## PUMP / JETS FUNCTION

 Press this pad to activate the pump

- 1st press – turns on low speed
- 2nd press – turns on high speed
- 3rd press – turns off pump

When low speed is already operating, the 1st press of the  pad puts the pump directly into high speed.

Low speed starts automatically every 30 minutes to measure water temperature (in STANDARD Mode only – see MODE FUNCTION), when a filter cycle is activated, or when a freeze condition is detected.

## PUMP AUTOMATIC TIME-OUT

- High speed – 15 minutes
- Low speed – 2 hours

## CLEAN-UP CYCLES



The Clean-up Cycle begins 30 minutes after the pump has been turned OFF or has automatically timed-out. The pump low speed and the ozonator (optional) will operate for one hour.

## FILTER CYCLES

The system will automatically activate the pump low speed to filter the water either once or twice each day, and can be programmed by the user. The first filter cycle begins 6 minutes after the spa is initially powered up. The second filter cycle begins 12 hours after the start of the first filter cycle. The filter cycle duration – length of time the pump low runs – is programmable from 1 to 12 hours (F1 to F12). The factory default is 2 hours, twice daily.

## PROGRAMMING FILTER CYCLES

To change the factory default filter cycle settings

Press  then  – the current filter cycle duration will be displayed



Press  again to adjust the filter cycle duration

Press  to exit programming mode and save changes.

## MODE FUNCTION

A combination of buttons is used to change swim spa operation to either 'STANDARD', 'ECONOMY' or 'SLEEP' mode.

## PROGRAMMING MODE FUNCTION

Press  then  – the current mode setting will flash on the display

Press  then  repeatedly to select mode

## STANDARD MODE

The system automatically starts the pump low speed every 30 minutes to measure water temperature, and maintain the set temperature. The display will show *SE* briefly, then the last measured water temperature. The current water temperature is displayed only after the pump has been operating for at least 2 minutes.

## ECONOMY MODE



The system will heat to the set temperature only during the filter cycles. The display will show *EC* when the temperature is non-current. When the temperature is current, the display will alternate between *EC* and the water temperature.

### SLEEP MODE

The system will heat to within 10°C (20°F) of the set temperature only during filter cycles. The display will show *SL* until the mode is changed.

### STANDBY / DRAIN ASSIST

The standby/drain assist feature stops the system from operating automatically, allowing for convenient filter cartridge removal and for safe draining of the swim spa. The following pads must be pressed within 3 seconds of each other.

Press  then the  pad - the display will flash *SBY*.

All functions will turn off, but the pump low speed can be activated (by pressing the  pad) to facilitate draining the swim spa - the display will show *DN*.

Press any pad other than the  pad to return the system to normal operation.

See DRAINING YOUR SWIM SPA- p. 49 - for detailed instructions.



### MOOD LIGHTING



#### STANDARD MOOD LIGHTING

Press the  pad on the topside control to turn the light on and off.

#### LED MOOD LIGHTING OPTIONAL - FACTORY INSTALLED

Press the  pad on the topside control to start the selection of LED lighting modes. Pressing the  pad on/off within 3 seconds cycles through the various 'light shows'. When the LED lighting is turned OFF for more than 5 seconds, then turned back ON, the system will resume the last 'light show'. For complete description of 'light shows', see MOOD LIGHTING - p. 19

The system will automatically turn off the mood lighting after 4 hours.

### OZONATOR OPTIONAL

The ozonator operates during FILTER CYCLES and CLEAN UP CYCLES only

### FREEZE PROTECTION

If the temperature sensor detects a drop to 4°C (39°F) within the heater chamber, the system automatically activates the pump to provide freeze protection. The pump will operate until the temperature reaches 5°C (41°F) before returning to normal system mode.

## TOPSIDE PANEL DISPLAY MESSAGES

### *OHH/HTR TEMP LMT/OH/HL* (solid)

Overheat – swim spa has shut down. One of the sensors has detected 48°C (119°F) at the heater.

**DO NOT ENTER WATER!** Remove cover and allow water to cool. Reset system by pressing any topside control panel pad. If system does not reset, shut off power and call your dealer.

#### POSSIBLE CAUSES OF OVERHEATING

- filter cycle too long or overlapping (pump running for extended periods of time)
- isolation/gate valves partially closed
- extremely hot weather/high ambient temperatures
- defective sensor wire

### *OHS/SPA TEMP LMT/OH/HL* (flashing)

Overheat – swim spa has shut down. One of the sensors has detected that the swim spa water is 44.5°C (112°F).

**DO NOT ENTER WATER!** Remove cover and allow water to cool. At 42°C (107°F) the swim spa control should automatically reset. If system does not reset, shut off power and call your dealer.

#### POSSIBLE CAUSES OF OVERHEATING

- filter cycle too long or overlapping (pump running for extended periods of time)
- isolation/gate valves partially closed
- extremely hot weather/high ambient temperatures
- defective sensor wire

### *ICE/FREEZE COND*

Potential freeze condition detected. Pumps will automatically activate when temperature drops to 4°C (40°F) regardless of operating mode.

### *Sn1/Sn3/Prr*

**Sn1** The high-limit temperature sensor is non-functional (open circuit). Swim spa control system is deactivated.

**Sn3** The water temperature sensor is non-functional (open circuit). Swim spa control system is deactivated.

**Prr** Indicates high-limit or water temperature sensor is non-functional.

### *SnA/SENSOR A SERVICE REQ*

Swim spa has shut down – sensor plugged into Sensor 'A' port not working.

### *SnB/SENSOR B SERVICE REQ*

Swim spa has shut down – sensor plugged into Sensor 'B' port not working.

### *SNS/SENSOR SYNC*

Sensors are out of balance – If topside display alternates between temperature and *SNS*, then occurrence may be temporary and will correct itself. The swim spa shuts down completely when the *SNS* message is flashing on the display.

### *HFL/HTR FLOW LOW*

A substantial difference in temperature between the sensors has been detected – this could indicate a flow problem. Check water level in swim spa and add if necessary. If water level is okay, make sure that pumps are primed and all gate valves are fully opened.

### *FLC/FLO/FL* (solid)

Indicates that system is detecting pressure at the pressure switch when the pump is not operating (switch is staying closed).

#### POSSIBLE CAUSES:

- static pressure (weight of water) in plumbing keeping pressure switch closed; usually associated with remote equipment location
- diaphragm in pressure switch coated with minerals due to improper water maintenance

### *FLO/FLO/FL* (Flashing)

Indicates that the system is not detecting pressure at the pressure switch while the pump is operating (switch is staying open).

#### POSSIBLE CAUSES:

- water level in swim spa may be too low
- isolation/gate valves partially closed
- air lock in pump reducing flow

### *LF/LOW FLOW*

Persistent low flow problem – displays on the fifth occurrence of an *HFL* message within a 24 hour period. Heater circuit is deactivated but other swim spa functions continue to operate normally. Check water level in swim spa and add if necessary. If water level is okay, make sure that pumps are primed and all gate valves are fully opened. Press any topside panel button to reset.



## TOPSIDE PANEL DISPLAY MESSAGES CONTINUED

**dr** / **HEATER MAY BE DRY-WILL RETEST SHORTLY**  
 Inadequate water detected in heater chamber - Check water level in swim spa and add if necessary. If water level is okay, make sure that pumps are primed and all gate valves are fully opened. Press any topside panel button to reset.

**dry** / **HEATER DRY SERVICE REQ**  
 Inadequate water detected in heater chamber - displays on third occurrence of a **DR** message within a 24 hour period. The swim spa shuts down completely when the **DRY** message is flashing on the display. Check water level in swim spa and add if necessary. If water level is okay, make sure that pumps are primed and all gate valves are fully opened. Press any topside panel button to reset.

**Pr** / **PRIMING MODE TAKES 4 MIN**  
 Priming mode - occurs when swim spa is first powered up, or when power has been restored after a power interruption. Allows for safe priming of the pumps. See section HYDROPOOL SWIM SPA CONTROL SYSTEMS for complete details.

**---** / **--F** / **--C**  
 Temperature unknown - after the pump has been operating for 2 minutes, the current water temperature will be displayed.

**---** / **----**  
 Temperature not current while in Economy or Sleep mode - In either of these modes, the pump may be off for hours in between filter cycles. To view the current swim spa water temperature, either switch to Standard mode or turn on the pump for at least 2 minutes.

**SbY** / **SbBY** / **STANDBY MODE**  
 Stops the control system from operating automatically to allow filter cartridge removal. Press any topside control button except for P1 to return to normal operation mode.

**drn** / **DRAINING**  
 Allows for convenient draining of the swim spa using the P1 low speed. Can only be accessed while in Standby mode. Press any topside control button except for P1 to return to normal operation mode.

**Std** / **STANDARD**  
 System is operating in **STANDARD** mode. See section HYDROPOOL SWIM SPA CONTROL SYSTEMS for complete details.

**Ecn** / **ECONOMY**  
 System is operating in **ECONOMY** mode. See section HYDROPOOL SWIM SPA CONTROL SYSTEMS for complete details.

**SE**  
 System is operating in **STANDARD-IN-ECONOMY** mode. See section HYDROPOOL SWIM SPA CONTROL SYSTEMS for complete details.

**SLP** / **SLEEP**  
 System is operating in **SLEEP** mode. See section HYDROPOOL SWIM SPA CONTROL SYSTEMS for complete details.

**COOL**  
 If water temperature is more than 7°C (20°F) cooler than the set temperature, the system will automatically activate the heater to provide freeze protection. This is a normal function; no corrective action is necessary.

## JET AND FEATURE OPERATION

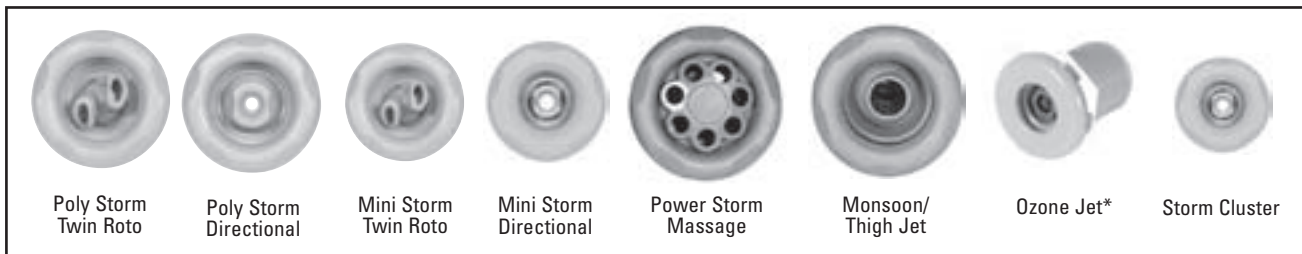

\* indicates a non-adjustable jet

### JET WATER FLOW ADJUSTMENT

Your Hydropool swim spa features adjustable water flow on specific hydrotherapy jets.

To reduce the flow: grasp the outer flange of the jet, and turn clockwise approximately a 1/4 turn. When it hits the stop, the jet is considered closed, and flow will be restricted.

To increase the flow: from the closed position, turn the jet counter-clockwise approximately 1/4 turn. When it hits the stop, the jet is open, and there is maximum jet flow. Do not attempt to turn the jet past the stop, as this will unthread the jet internal from the socket.

### JET AIR FLOW ADJUSTMENT

Your Hydropool swim spa features adjustable air flow on specific hydrotherapy jets.

To **reduce the flow**: turn the handle on the air control clockwise. When it hits the stop, the air is closed, and air flow will be restricted.

To **increase the flow**: turn the handle on the air control counter-clockwise. When it hits the stop, the air control is fully opened.

For maximum operating efficiency, the air controls must remain closed when your swim spa is not in use.

All Hydropool swim spas are shipped from the factory with the jets in the open position.

### INTERCHANGING JET INSERTS

A great feature for custom tailoring the jets in your Hydropool swim spa to suit your personal hydrotherapy needs. Jets of like size and dimension may be interchanged with each other, for example, if you wished to swap a standard pulsator jet for a standard adjustable blaster jet, or a medium pulsator jet for a medium adjustable jet.



### JET INSERT REMOVAL & REPLACEMENT

#### POLY/MINI STORM DIRECTIONAL & TWIN ROTO POWER STORM MASSAGE & STORM CLUSTER

##### TO REMOVE:

- Turn the jet counter-clockwise to unclip & pull out of socket.

##### TO RE-INSTALL:

- Push the jet into the socket until it snaps into place, ensuring the square pin on the back of the jet lines-up with the groove in the socket flange. Rotate jet right or left to ensure it is properly seated.



## JET AND FEATURE OPERATION

### ADJUSTABLE FLOW CONTROL AQUATRAINER & AQUASPORT ONLY

Your HydroPool swim spa is equipped with 3 DIVERTER valves to control and adjust water flow to suit individual user requirements.

The pump 1 (P1) DIVERTER valve provides variable water flow adjustment between the lower centre swim jet (providing added bouyancy and variable swim resistance), and the hydrotherapy jets on the bucket seats, or a combination of both.

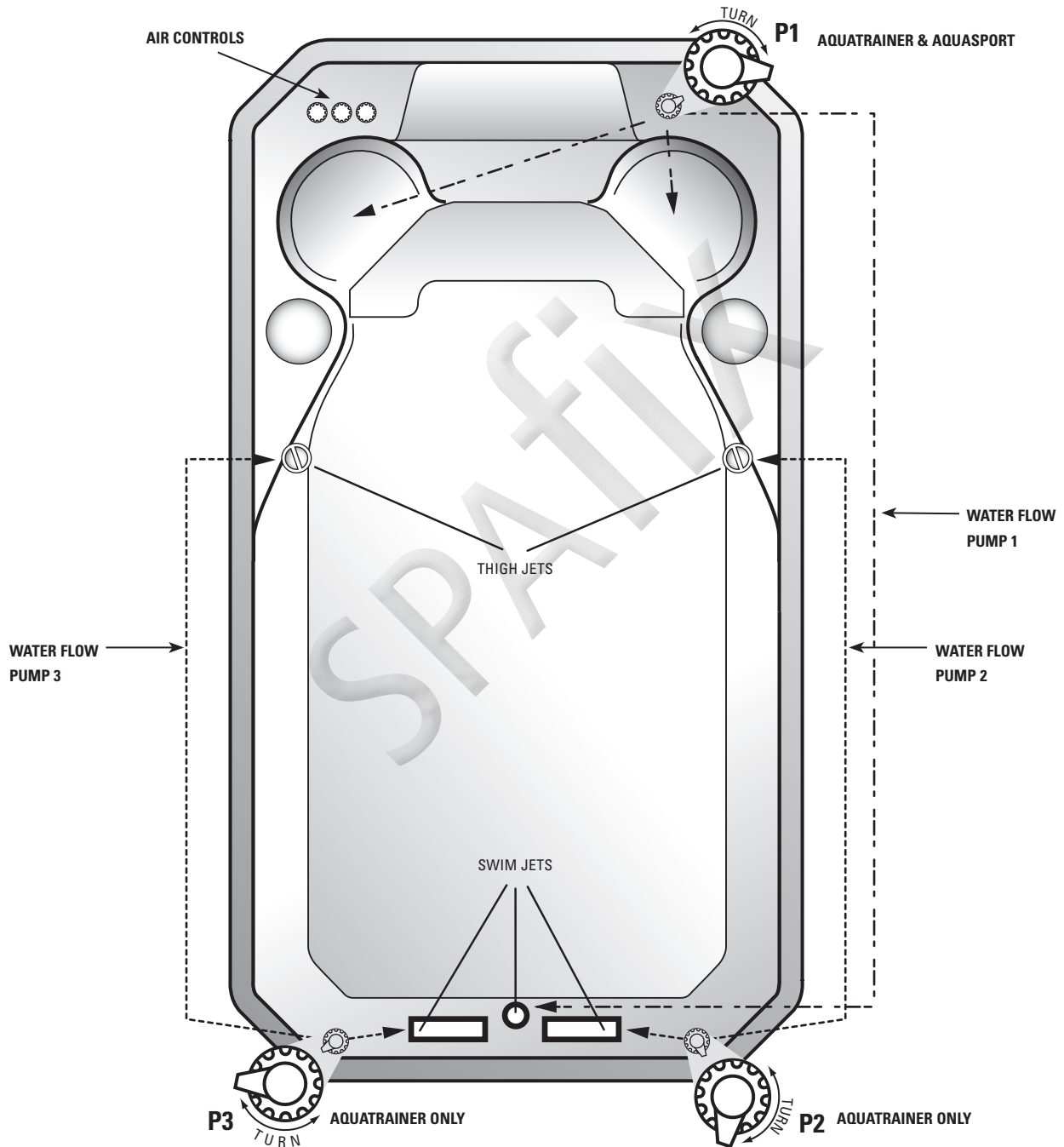

The pump 2 and pump 3 (P2 & P3) DIVERTER valves provide variable water flow adjustment between the two upper swim jets (providing variable swim resistance), and the two thigh jets on either side of the swim spa (providing variable resistance for water-aerobic exercises or hydrotherapy needs).

## SWIM SPA WATER BALANCE – GENERAL OVERVIEW

### NOTABLE POINTS

- The reliability and longevity of your swim spa support equipment is directly related to how well water quality is maintained!
- ALWAYS observe and follow the instructions on the chemical container.
- The relatively small volume of water in your swim spa is easily affected by external factors such as oils, lotions, perspiration and chemicals. It is imperative that you give your swim spa regular attention to maintain clean, safe and balanced water to prevent premature damage and/or failure (corrosion/calcification) to the electrical support equipment. Maintaining your swim spa water balance, while simple, is extremely important. Neglected water will allow bacteria to quickly spread.
- The mineral content of swim spa water increases from water evaporation, sanitizers and other chemicals. If the mineral concentration, particularly calcium, becomes too high, the minerals will literally “drop” or precipitate out of the water and deposit on the swim spa walls, plumbing, jets, in the filter and on the heater element.
- It is very important that pH be checked frequently and maintained in the recommended range as indicated in the chart WATER BALANCE SUMMARY FOR YOUR SWIM SPA - p. 45

- It is also very important that Total Alkalinity (the ability of the water to resist a change in pH) be maintained in the recommended range as indicated in the chart on the following page.
- Although there may be two identical swim spa models right next door to each other, the maintenance requirements will be different, dependant on such factors as:
  - bather load
  - frequency of use/quantity of bathers
  - different body chemistry
  - sun vs. shade
  - temperature

For these reasons, it is very important to develop proper swim spa water maintenance habits and follow your dealers recommended water maintenance procedures.

Your HydroPool dealer will advise you as to what method they recommend.



Heater and other component failure due to improperly maintained pH or Total Alkalinity levels will not be covered under warranty.

## GLOSSARY OF COMMON WATER MAINTENANCE TERMS

- **CHLORINE** – in granular, liquid or puck/tablet form, is an oxidant and biocidal agent. It is very effective and fast acting. Recommended chlorine residual level is 3.0 to 5.0 ppm.
- **CHLORAMINES** – a compound formed when chlorine combines with nitrogen or ammonia present in the water. When allowed to go unchecked, it causes eye and skin irritation and is indicated by a strong chlorine odour.
- **ONE-PART BROMINE** – also available in puck/tablet form, is another type of oxidant/biocidal agent, and is introduced into the swim spa water via a brominator. Recommended bromine residual level is 3.0 to 5.0 ppm
- **TWO-PART BROMINE** – composed of a liquid or powder component introduced manually into the water on a weekly basis, and a granular component that is added daily or as the swim spa is used.
- **BROMAMINES** – are formed when bromine destroys nitrogen-bearing organic matter. Unlike chloramines, bromamines don't cause eye irritation, however, when allowed to go unchecked, will cause an objectionable odour.
- **SHOCK** – the practice of adding an oxidizing agent to swim spa water to destroy ammonia, nitrogenous and organic contaminants (chloramines and bromamines)
- **pH** – a logarithmic value expressing the relative acidity or basicity of a substance (such as swim spa water) as indicated by the hydrogen ion concentration. pH is expressed as a number on a scale of 0 to 14, where 0 is most acidic, 1 to 7 being acidic, 7 considered neutral, 7 to 14 being basic, and 14 being most basic. The ideal range for swim spa water is 7.4 to 7.6 ppm
- **pH INCREASER** – raises the pH level of the water.
- **pH DECREASER** – lowers the pH level of the water.
- **TOTAL ALKALINITY (TA)** – the amount of carbonate, bicarbonate and hydroxide compounds present in the water that determines the ability or capacity of the water to resist change in pH. Also known as the 'buffering' capacity.
- **ALKALINITY BOOSTER** – raises the alkalinity.
- **CALCIUM HARDNESS** – the calcium portion of the total alkalinity which represents 70 to 75% of total hardness. Calcium concentrations determine whether water is 'soft' – too little calcium, or 'hard' – too much calcium.
- **CALCIUM BOOSTER** – increases the calcium level.
- **TOTAL DISSOLVED SOLIDS (TDS)** – a measure of the total amount of dissolved matter in the water (calcium, carbonates, bicarbonates, magnesium, metallic compounds, etc.)
- **SEQUESTERANTS (STAIN AND SCALE CONTROLLERS)** – keeps dissolved metals and minerals in the water from attacking the swim spa shell and support equipment components.
- **DEFOAMER** – removes foam build-up from the water surface. At best, this is a temporary remedy, as excessive foam is merely a symptom of improper water balance (typically high organic residue and/or high pH).
- **CARTRIDGE FILTER CLEANER** – degreases and cleans cartridge filters.
- **OZONATOR** – generates Ozone (a gaseous molecule composed of 3 atoms of oxygen) and is injected into the swim spa water for the oxidation of water contaminants.
- **TEST KIT** – used to monitor specific chemical residual or demands in the water. May be in the form of litmus strips or liquid drops.
- **PPM** – abbreviation for 'parts per million', the unit of measurement used in chemical testing which indicates the parts by weight in relation to one million parts by weight of water. Essentially identical to the term mg/L – milligrams per liter.

### WATER BALANCE SUMMARY FOR YOUR SWIM SPA\*

SANITIZER (ppm)	MIN	IDEAL	MAX
Chlorine	1.0	3.0 - 5.0	10.0
Bromine	2.0	3.0 - 5.0	10.0
<b>CHEMICAL</b>			
PH	7.2	7.4 - 7.6	7.8
Total Alkalinity (TA)	80	80 - 120	180
**Total Dissolved Solids (TDS)	300	1000 - 2000	3000
Calcium Hardness	150	200 - 400	500 - 1000

\* National Spa & Pool Institute recommended levels

\*\* Organic TDS

## SIGNS OF IMPROPER WATER BALANCE

### CLOUDY WATER

Cloudy water can be caused by:

- high total dissolved solids (TDS) thereby requiring full or partial water drainage
- a low sanitizer level
- incorrect pH requiring balancing
- suspended particles necessitating a filter cleaning
- insufficient filtration time

### FOAMING

Foaming is caused by the agitation of total dissolved solids (TDS). This can be caused by the buildup of too much chemical by-products in the swim spa water, people not showering before using the swim spa, body lotions, etc. To correct, add a small amount of foam eliminator and turn on jets to circulate the water. At best, this is a temporary remedy, as excessive foam is merely a symptom of improper water balance. In extreme cases, the water will require draining and the filter will require cleaning.

### SKIN IRRITATION

Most skin irritation is caused by too high or too low pH. Test and adjust. Where irritation continues, consult your physician.

## CORONA DISCHARGE OZONE TECHNOLOGY

All Hydropool swim spas are factory prepared to accommodate ozonators. The Hydropool Corona Discharge Ozonator is regarded as the most technologically advanced system on the market, allowing longer contact time with the swim spa water resulting in reduced chemical consumption and clearer, cleaner water.

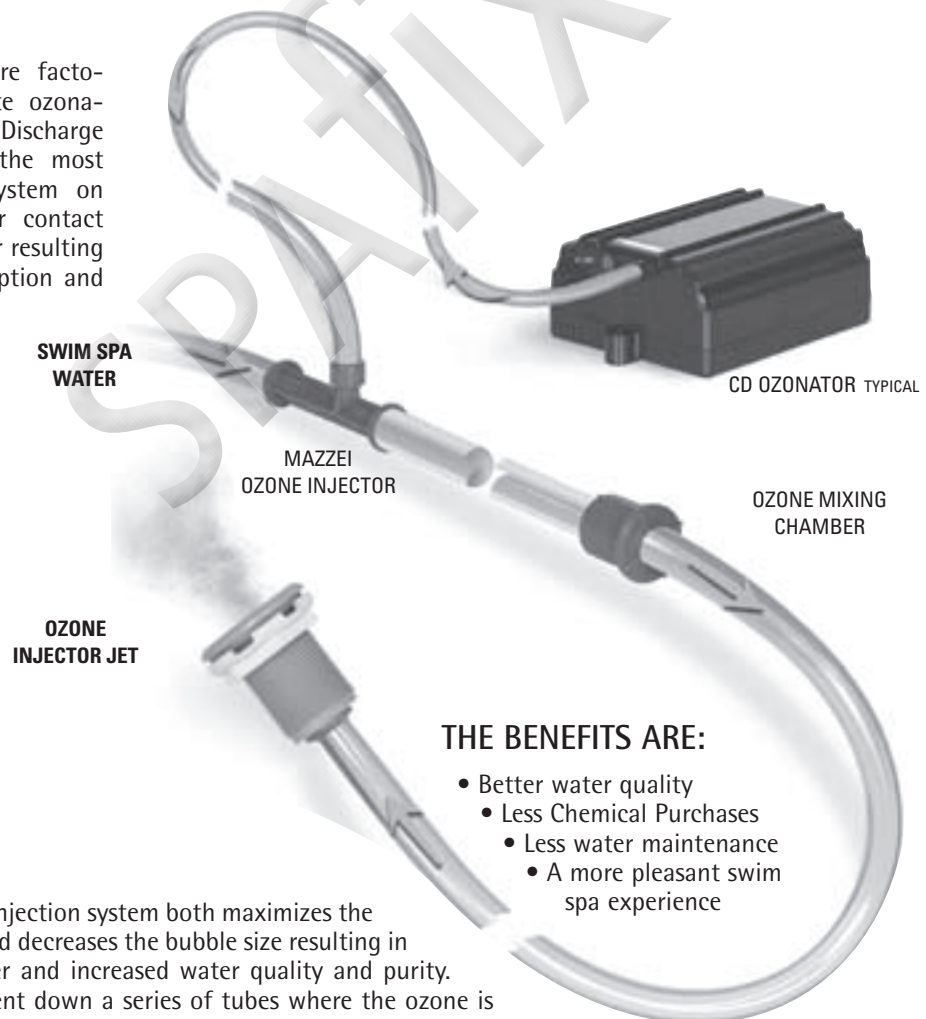

### THE BENEFITS ARE:

- Better water quality
- Less Chemical Purchases
- Less water maintenance
- A more pleasant swim spa experience

The unique Hydropool ozone injection system both maximizes the dispersion of the ozone gas and decreases the bubble size resulting in longer contact with the water and increased water quality and purity. The ozone/water mixture is sent down a series of tubes where the ozone is "broken down" into even smaller bubbles before being re-mixed with the water reducing the "off-gassing" commonly found with other ozone systems.

## SUGGESTED ROUTINE WATER MAINTENANCE



**ALWAYS FOLLOW THE INSTRUCTIONS ON THE LABEL OF THE CHEMICAL CONTAINER TO DETERMINE THE CORRECT RATIOS**

### INITIAL FILL

- 1 Make sure the swim spa water is circulating.
- 2 Add a sequesterant (stain and scale controller). Allow water to circulate for an hour before adding anything else to the swim spa water.
- 3 Add a Shock / oxidizing agent .
- 4 Add sanitizing tablets (Bromine or Chlorine) to the dispenser:

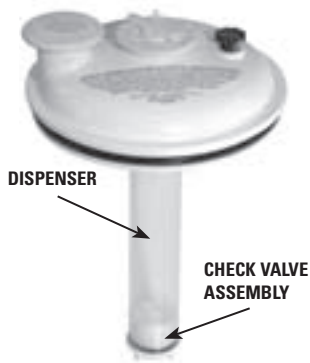

- Built in dispenser: if your Hydropool swim spa was ordered with the optional built in bromine/chlorine dispenser, (located in the lid of the cartridge filter housing), refer to section **CARTRIDGE FILTER** - p. 48 for details on removing and re-installing the lid. Once the filter lid is removed, you'll notice a clear 2.5 cm (1") diameter tube extending from the bottom of the

lid. Unscrew the check valve assembly at the end of the tube and add 5 or 6 tablets. Do not overfill dispenser as performance will be affected. Reinstall check valve assembly. Set the dial initially to '5', and allow water to circulate for 3 to 4 hours before testing level. Adjust dial more or less as necessary.

The tablets will dissolve slowly over a 10-14 day period, depending on dial setting, and use of the swim spa.

- 5 Test pH and Total Alkalinity and adjust accordingly.

### DAILY

- 1 Test water, and if necessary, add shock.
- 2 Ensure proper water level is maintained.

### WEEKLY

- 1 Test pH and Alkalinity. Adjust accordingly.
- 2 Top-up chemical dispenser.
- 3 Add sequesterant (stain and scale controller).
- 4 Remove and spray cartridge filter with garden hose and re-install (see section **CARTRIDGE FILTER** - p. 48).
- 5 Remove and clean out skimmer basket (see section **CLEANING THE SKIMMER BASKET**).
- 6 Add Shock / oxidizing agent.

### MONTHLY

- 1 Soak your filter cartridge in a filter cartridge cleaning solution. Rinse thoroughly and, if possible, allow to dry before re-installing. Hydropool recommends purchasing a second filter so that while the first is cleaning, the other is clean and ready to install.

### ANNUALLY

- 1 Drain swim spa at least once per year and clean the acrylic shell surface with a non-abrasive cleaner designed specifically for acrylic surfaces see sections **CHANGING THE SWIM SPA WATER** and **DRAINING YOUR SWIM SPA** - p. 49

### CHEMICAL SAFETY HINTS

- Never pre-mix chemicals with each other prior to adding to swim spa water.
- Add only one chemical to the water at a time.
- Always add chemicals to water, not water to chemicals
- Chemicals may be corrosive, so handle with care and store in a cool dark place.
- Never smoke near chemicals as most are flammable
- Ensure any spilled chemicals are carefully cleaned up immediately.
- Always have the **POISON CONTROL** telephone number handy in the event of an emergency.
- Keep chemicals out of children's reach
- Wear safety glasses and gloves when handling chemicals.

### CLEANING THE SKIMMER BASKET

- 1 Activate the **STANDBY/DRAIN ASSIST** mode
- 2 Remove the skimmer basket by pulling the weir door forward, and pulling the basket up and towards the front.
- 3 Remove debris from basket. (Note: Avoid hitting the basket against objects to knock debris loose as this may damage the unit).
- 4 Reinsert basket.
- 5 Take the system out of **STANDBY/DRAIN ASSIST** mode, and as the pump begins to operate, monitor water flow over the weir door to ensure that it is free floating.



## CARTRIDGE FILTER

The cartridge should be cleaned every two to four weeks, depending on the amount of use. Signs that the filter requires cleaning include:

- Reduced jet power
- Hazy gray water
- Rattling noise in the pump or filter
- Heater not working

### REMOVAL

- 1 Activate the STANDBY/DRAIN ASSIST mode. SEE HYDROPOOL CONTROL SYSTEMS - p. 22
- 2 Remove the filter cover and open the small, black air vent/bleeder valve on the top of the filter lid.
- 3 Press down the lock tab to disengage and turn the locking ring counter clockwise.
- 4 Pull the filter lid upwards, and lift the cartridge element straight up and out of the filter housing.

### CLEANING

- 5 With a garden hose and spray nozzle, hose off the cartridge element, ensuring to carefully separate every pleat.
- 6 To remove collected lotions, body oils, etc. soak the cartridge in warm water and a filter cleaning/emulsifying compound (available at your HYDROPOOL dealer).
- 7 A cleaning cylinder may be purchased from your HYDROPOOL dealer.
- 8 Rinse thoroughly and dry before replacing.
- 9 HydroPool recommends purchasing a spare filter cartridge so that you always have a clean substitute ready to rotate.
- 10 After the element has dried - if necessary, lightly brush between pleats with a fine paint-brush to remove remaining dirt particles.



Do not use a wire brush or other device to clean cartridge element. Do not put in dishwasher or washing machine.

### RE-INSTALLATION

- 11 Place the cartridge filter back into the filter housing.
- 12 Replace the filter housing lid, pushing it down to seat, ensuring that the lid o-ring does not become twisted.
- 13 HydroPool recommends that the lid o-ring be lubricated with a non-petroleum based lubricant (ie. Silicone gel) when it becomes dry. This will help to prevent twisting and pinching as the lid is installed, and significantly increase longevity of the o-ring.
- 14 Install the filter lock-ring, turning clockwise until the lock tab snaps into place.
- 15 Close the air vent/bleeder valve.
- 16 Take the system out of STANDBY/DRAIN ASSIST mode.
- 17 When the pump starts circulating on low speed, it will be necessary to release trapped air in the filter. Carefully loosen the vent valve counter-clockwise until there is the hissing sound of air escaping. Once there is a steady stream of water, close the vent valve, ensuring that the o-ring does not become pinched.

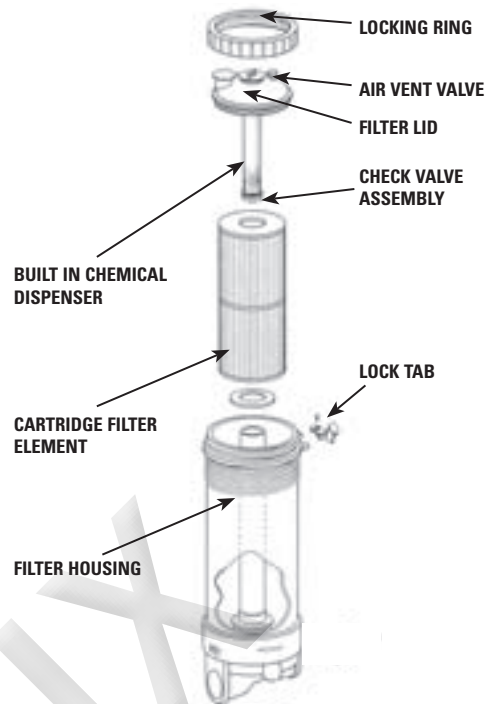

### CLEANING THE ACRYLIC SURFACE

The acrylic surface can be cleaned and polished using a soft cloth and acrylic cleaner, available at your HydroPool dealer.



- **Important: Do not use detergents** - the remaining residues will adversely affect water chemistry, making it difficult to maintain proper water balance
- **Do Not use abrasive cleaners** - damage to the acrylic surface will occur.

### SAFETY HARD COVERS OPTIONAL

When a swim spa is uncovered, over 90% of heat is lost from the water surface. This evaporation also affects the chemical balance. HydroPool Safety Hard Covers are engineered for maximum thermal efficiency and appearance. They are hinged in the middle for easier handling, and the zip fastener allows the tapered foam inserts to be changed if damaged. The handles are placed so that even one person can easily carry a large cover. The locks, with one part fastened to the deck or cabinet, prevent small children or animals from entering the swim spa. Do not drag the safety hard cover across the swim spa or decking; always lift by the handles. Standing on the hardcover could cause the tapered foam inserts to crack, which will lead to water absorption.

### NEVER LEAN OR STAND ON YOUR HARDCOVER.

The cover should be cleaned at least twice a year with a vinyl moisturizer and protector.



## CHANGING THE SWIM SPA WATER

The water in your swim spa must be carefully monitored and drained regularly as required, depending on size and amount of use. Draining at least once annually is strongly recommended and offers the opportunity for inspection of jets and suction fitting covers. If your swim spa is used daily or by a large number of bathers, the water should be drained more often. One method to determine the approximate length of time between water changes is to divide the water volume (in litres) of your swim spa by 13.5 and then divide by the average number of bathers each day.

Formula  $\left( \frac{\text{Volume of water in litres}}{13.5} \right) \div \left( \frac{\text{Average daily bathers}}{\text{Days between water changes}} \right) = \left( \frac{\text{Days between water changes}}{\text{Average daily bathers}} \right)$

14 ft. model = 6511 L / 17 ft. model = 8214 L

### EXAMPLE:

1000 litres divided by 13.5 divided by 2 = 37 days.

The swim spa water must be changed when the amount of dissolved solids becomes excessive, and is usually indicated by "gray" or dull looking water.

## DRAINING YOUR SWIM SPA

- 1 Locate nearest drain facility (shower, laundry tub, floor drain, lawn, etc.).
- 2 Put the swim spa control system into STANDBY/DRAIN ASSIST mode.
- 3 Remove the skimmer basket so that the hole beneath it is accessible, and insert the #10 rubber expansion plug provided.
- 4 Unroll blue drain hose located on plumbing line beside the swim spa control system.
- 5 Run blue drain hose to drain location.
- 6 Open gate valve on drain line.
- 7 Close pump1 return gate valve (this directs the water out the drain line).
- 8 Activate the low speed pump.
- 9 Monitor the swim spa while it drains.
- 10 Use a garden hose to wash down interior surface as the swim spa continues to drain. A sponge may also be used to wipe down the interior surface. See section CLEANING THE ACRYLIC SURFACE - p.48

- 11 Turn OFF the low speed pump once draining is complete.
- 12 Open pump 1 return gate valve.
- 13 Remove the #10 rubber expansion plug from the bottom of the skimmer housing.
- 14 Add fresh fill water until level is approximately 19mm (3/4 in.) from the top of the skimmer opening.
- 15 Press any button on the topside control panel (other than the pump 1 button) to take the system out of STANDBY/DRAIN ASSIST mode. Pump 1 low speed and the heater will activate to circulate and heat the water.
- 16 If the filter housing was opened to replace the cartridge filter, it will be necessary to release trapped air from the filter housing by carefully loosening the small black air vent valve located on the top of the filter housing. When water begins to escape close the air vent valve.
- 17 In the unlikely event of a pump air lock (pump 1 is operating but there is no water movement from the jets), refer to section PUMP PRIMING/RELEASING AN AIR LOCK - p. 21

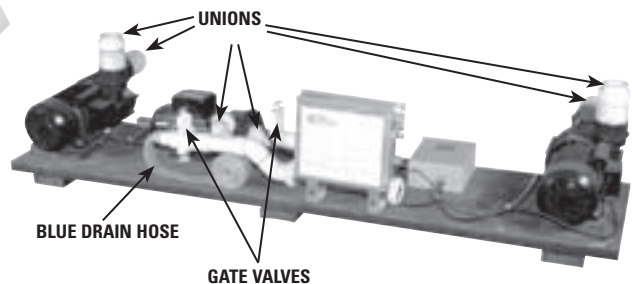

## WATER SOFTENERS

Never fill a swim spa with water from a water softener, as it could adversely affect the water chemistry, making it difficult to maintain proper water balance. If you live in an area with hard or soft water, give careful attention to your Calcium Hardness level. Topping up with soft water is acceptable.

## WOOD CABINET OPTIONAL

### CABINET INSTALLATION INSTRUCTIONS

Prior to installing the factory optional knockdown cabinet, ensure your swim spa has been filled and running for at least 48 hours. This will allow time to adjust the steel support legs and inspect for potential leaks.

- 1 Make sure your swim spa is full of water and the steel leveling legs are properly adjusted
- 2 First, slide the equipment cover end (A) over the equipment pad to within about 1" of the underside of the swim spa lip
- 3 Assemble the two-piece side panels and place one of the assemblies (B or C) along the side of the swim spa. Using the screws provided, attach side panel to the equipment cover end (A) at the top and bottom where the guide holes are located.

- 4 Repeat panel assembly step #3 for the other side
- 5 Next, attach the end panel (D) to the two side panels (B & C) with the screws provided.
- 6 Once assembly is completed, adjust the leveling feet on the bottom of the cabinet to bring the cabinet top rail to meet the under side of the lip around the entire swim spa.
- 7 Install chrome trim (if desired) around the edge of the swim spa shell where the shell meets the cabinet top rail.

**Note:** for concrete base dimensions refer to chart in section SITE PREPARATION FOR... p. 7

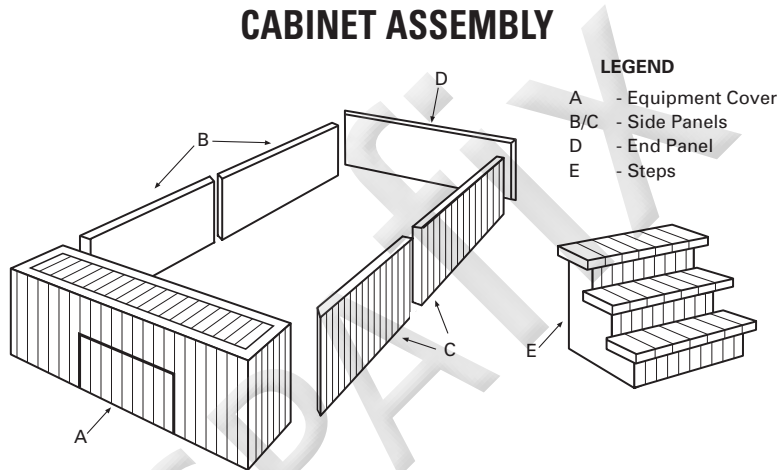

## PROTECTING YOUR CABINET WOOD FINISH

HYDROPOOL swim spa cabinets are made from Western cedar and are factory stained. Once stained, cedar weathers well, and with proper care will maintain its beauty for many years. For a protective translucent finish and to enhance the wood grain beauty, Sikkens Cetol 01 #077 stain and Sikkens

Cetol 23 #078 or an equivalent polyurethane or marine varathane with UV inhibitors is highly recommended. These protective finishes stabilize the wood grain and build a durable, breathable water-repellent barrier between the wood surface and the elements. These products are available from your local building supply center.

## CABINET WING-LOCKS

The high quality wing-locks provided on your HydroPool swim spa cabinet not only firmly secure the equipment access panel, they also serve as convenient handles for removal and replacement. In order to maintain optimum performance and extended life, HydroPool recommends lubricating twice annually with a silicone based lubricant.

**RECOMMENDED PRODUCT:** Super-Lube silicone based lubricant (or equivalent). Available at your local building supply center.



Do not use a petroleum based lubricant, as this will cause premature deterioration of the lock seal.

## WINTERIZING YOUR HYDROPOOL SWIM SPA

In the event that you do not wish to use your swim spa year-round, it is very important that you properly winterize to protect against damage from freezing. Your HYDROPOOL dealer can perform such a service for a nominal fee. If you choose to winterize your swim spa yourself, please follow the guidelines below:

- Drain the swim spa entirely see section - DRAINING YOUR SWIM SPA- p. 49.
- Remove and clean the cartridge filter element see section - CARTRIDGE FILTER - p.48.
- Using a wet/dry utility vacuum, remove remaining water from the jet openings, filter cartridge housing, and footwell.
- Either pour or use a turkey-baster where necessary to add **potable biodegradable RV antifreeze** to areas such as pump wet end, jet channels and filter housing. **DO NOT USE AUTOMOTIVE ANTIFREEZE.**
- Unthread and disconnect all unions in the support equipment area. Remove lowest winter drain plug on pump face plate. Repeat for all pumps, where applicable.
- Cover exposed plumbing connections with plastic bags and duct tape.
- Where practical, disconnect swim spa support equipment and store in a dry heated area.

- Install the safety hardcover, and cover the entire swim spa with a tarp to prevent premature weathering of the cabinet and the safety hard cover.
- Remove snow build up regularly to prevent damage to the safety hard cover.
- It is assumed that your HydroPool swim spa has been properly installed on a reinforced concrete pad to reduce the potential of lifting due to hydrostatic ground water pressure.



If you are not 100% confident that your swim spa is properly winterized, please consult your authorized HydroPool swim spa dealer. Caution recommends that an authorized HydroPool Dealer winterize your swim spa in the initial year. Damage as a result of freezing is not covered by the warranty.

### IMPORTANT NOTE

For inground installations where risk of freezing temperatures exists: after winterizing you must refill your swim spa with a minimum 61 cm (24 in.) of water to counter static ground pressure.

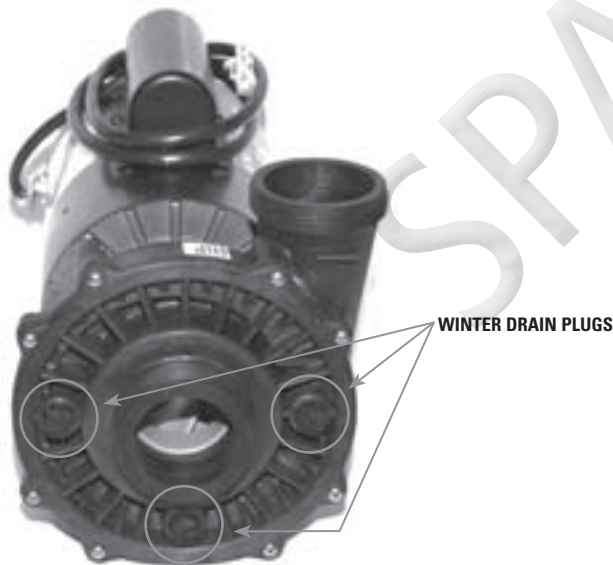

## GENERAL TROUBLESHOOTING

### ELECTRICAL/MECHANICAL

SYMPTOM	POSSIBLE REASON(S)	ACTION
No Power	<ul style="list-style-type: none"> <li>- Breaker off at main panel or fuse out</li> <li>- Improper wiring</li> <li>- Fuse blown in control</li> <li>- G.F.C.I. tripped</li> </ul>	<ul style="list-style-type: none"> <li>- Verify that breaker and/or GFCI are on.</li> <li>- If still there is no power, call dealer or electrician</li> </ul>
G.F.C.I. Trip	<ul style="list-style-type: none"> <li>- Short or ground in system</li> <li>- Faulty G.F.C.I.</li> </ul>	<ul style="list-style-type: none"> <li>- As above-call Electrician or Hydropool Dealer</li> </ul>
No Circulation	<ul style="list-style-type: none"> <li>- Pump is not primed (air lock)</li> <li>- Gate valves are closed</li> <li>- Water level in spa is too low</li> <li>- Skimmer obstructed or closed</li> </ul>	<ul style="list-style-type: none"> <li>- See PUMP PRIMING/RELEASE AN AIR LOCK p.21</li> <li>- Open gate valves (p.20)</li> <li>- Top up water to proper level (p.20)</li> <li>- See CLEANING SKIMMER BASKET p.47</li> </ul>
Jet Surge	<ul style="list-style-type: none"> <li>- Water level too low</li> <li>- Blockage in lines</li> <li>- Suction gate valve partly closed</li> </ul>	<ul style="list-style-type: none"> <li>- Add water to correct level (p.15)</li> <li>- Check gate valves and/or skimmer basket</li> <li>- Pull gate valve handle "up" all the way (p.20)</li> </ul>
No Heat	<ul style="list-style-type: none"> <li>- pressure switch not closing</li> <li>- Hi Limit switch tripped</li> <li>- Cartridge filter dirty</li> <li>- Low water</li> <li>- Faulty pressure switch</li> </ul>	<ul style="list-style-type: none"> <li>- See TOPSIDE PANEL DISPLAY MESSAGES p.40</li> <li>- See TOPSIDE PANEL DISPLAY MESSAGES p.40</li> <li>- Clean &amp; reinstall (p.48)</li> <li>- Top Up (p.20)</li> <li>- Call dealer</li> </ul>
Erratic Heat	<ul style="list-style-type: none"> <li>- Low Water</li> <li>- Incorrectly adjusted pressure switch</li> <li>- Faulty sensor</li> </ul>	<ul style="list-style-type: none"> <li>- Top Up (p.20)</li> <li>- Call dealer</li> <li>- Call dealer</li> </ul>
Noisy Motor	<ul style="list-style-type: none"> <li>- Damaged or worn bearings</li> <li>- Low voltage</li> <li>- Low water level</li> <li>- Frozen pump</li> </ul>	<ul style="list-style-type: none"> <li>- Call your Electrician or Hydropool dealer.</li> <li>- Call Electrician</li> <li>- Top Up (p.20)</li> <li>- Thaw out (p.53)</li> </ul>
Digital Top Side No Longer Displays	<ul style="list-style-type: none"> <li>- Improper connection</li> <li>- Electrical brown-out</li> </ul>	<ul style="list-style-type: none"> <li>- Call dealer</li> <li>- Reset GFCI OFF/ON (p.53)</li> </ul>
Digital Temperature Display is Erratic or Flashing	<ul style="list-style-type: none"> <li>- Water temperature has exceeded set point</li> </ul>	<ul style="list-style-type: none"> <li>- Decrease filter cycle</li> </ul>

## GENERAL TROUBLESHOOTING CONTINUED

### WHAT TO DO IN THE EVENT OF...

#### ...POWER FLUCTUATIONS

The power supply into your home is, for the most part, fairly consistent. However, when local power demand is high, there is a tendency for the voltage entering your home to drop (sometimes significantly) or fluctuate. This condition is referred to as a 'brown-out'. Although safeguards have been built into the system to protect against this condition, supply voltage may drop low enough, if even for a second, to cause the system to display a 'ghost' message. Should this occur or if the display shows partial messages, try resetting the system by turning power to the swim spa off, waiting a few minutes, then turning power on again. If this does not reset the system, contact your local dealer or service organization.

#### ...POWER FAILURE OR SYSTEM FAULT DURING COLD WEATHER CONDITIONS

If your control system will not reset, (ie. GFCI trips) or if your pump will not circulate for any other reason, place a low wattage space heater or hair dryer under the cabinet in the equipment area. This will delay the risk of freezing while a service appointment is scheduled.

### NOTES:

SPAFIX

## NOTES:

## NOTES: